

# WOODMASTER MINI BOILER

Retain this manual

# WOODMASTER<sup>®</sup> PELLET BOILER



## POWERED BY THE RENOVATOR PELLET BURNER

[www.woodmaster.com](http://www.woodmaster.com) / 800-932-3629 / Manual PN: 7994-890

Northwest Manufacturing, Inc / 600 Polk Ave SW / Red Lake Falls, MN 56750

Rev:2.3/Software V22



# TABLE OF CONTENTS

Terms ..... 3

Safety ..... 4-5

Technical Features ..... 6

Fuels ..... 7

Installation ..... 8-21

Operation ..... 22-25

Maintenance ..... 26-35

Wiring Diagram ..... 36-37

Troubleshooting ..... 38

Warranty ..... 39-42

Specifications ..... 43



*Thank you for purchasing a quality Mini Pellet Boiler from WoodMaster. This product was designed to deliver easy, trouble free operation for years to come. Check out other WoodMaster heating products at [www.woodmaster.com](http://www.woodmaster.com), or our line of quality pellet grills at [www.woodmasterpelletgrills.com](http://www.woodmasterpelletgrills.com).*

# TERMS



**Renovator** AKA Burner or Pellet Gun - Combustion chamber that burns pellets

**Air Compressor** - On board air cleaning agent

**PLC** - Programmable Logic Control - Controls the burner

**Start Dose** - Amount of fuel need to initiate ignition (approx. 5.25 oz, 150 grams, and 8.5 oz in volume)

**Photo Sensor** - Read the photo resistance value to control the flame from ignition to combustion

**Auger Spiral** - Feed auger screw

**Pellets** - Wood sawdust compressed into small cylinders to be used as fuel

**Fault** - An error or malfunction during the ignition or combustion process

**Flue** AKA Chimney - any duct or passage for air, gas or exhaust

**O<sub>2</sub>** The oxygen that is in the flue gas

**Flue Gas Analyzer** - O<sub>2</sub> sensor that is used to properly calibrate the air to fuel ratio of the burner.  
(Testo 327, 320, 310)

**End Stop** - Replaceable plate at the end of the burn pot that prevents the pellets from falling off the burn pot

**Flame Guard** - A guard that prevents the flame from going up the intake chute

**Igniter** - A heating element that automatically ignites the pellets

**Tipping Chute** - The fuel inlet pipe on the Renovator

**Combustion Fan** - The fan that controls the air flow for combustion

**Temp Sensor** - Temperature sensor that detects the boiler water temperature

**Hopper** - Storage container used to hold pellets

**Blow Down** - The process of removing sediment deposits from the boiler by draining water from the bottom of the unit(s) until the water runs clean

**Firebox** - Chamber where the flame is present

**Water Jacket** - Steel casing that surrounds the firebox and holds the water/antifreeze

**Turbulator** - Cleaning device located in heat exchangers that also increase efficiency

**Draft Inducer** - Fan that assists the combustion process to ensure a proper burn under all conditions

- **Read and follow these directions carefully. Retain this manual for as long as you own your boiler.**
- **All installation and operations must follow STATE and LOCAL CODES for wiring, and firing of this unit. These CODES may differ from this manual. Installation must be performed by a qualified installer.**
- **Follow the manual carefully. Follow the recommended cleaning and maintenance.**
- **The WoodMaster Mini 30 is designed to be operated in a pressurized system. Make sure all necessary safety components are installed and functioning properly.**
- **Freeze protection must be guaranteed in all water-bearing parts in the event of extensive idle periods of the system. Note: Your WoodMaster Mini 30 is not intended to be your only heat source.**
- **Boiler water treatment must be used to ensure proper water quality.**
- **The chimney height may need to be adjusted depending on the installation and local codes. Do not connect this unit to a chimney flue serving another appliance. Follow all state/local codes.**
- **Never open the ash door or top door during operation!**
- **Never operate any part of the system with covers, shields or panels removed.**
- **Anyone who is not familiar with and/or has not been trained to operate the boiler may not operate the system. Only responsible adults should operate your boiler. If the boiler is not fired properly damage could result and the warranty may be voided.**
- **Never allow children to play near or tamper with the burner, fuels/fuel tank or any other part of the system.**
- **Always keep the area around, and in front of the system clean and free from combustible materials.**
- **Keep animals away from the system.**
- **The operation may not be continued or restarted in the event of visible damages (for example, thermal distortion, traces of smoke or fire, mechanical damages, etc.). Any damages must be repaired. In the event of any doubts, please contact your authorized WoodMaster dealer.**
- **The system must not be exposed to external mechanical stress (for example, as storage, climbing support, brace, or similar). This also applies for single parts (doors, covers, etc.).**
- **Only touch the PLC during the operation. Temperatures at other points (for example, chimney, ash door, water lines...) can be very high.**
- **The WoodMaster Mini 30 must be operated exclusively according to the guidelines for planning, assembly, regulations, statutes and product related instructions. The manufacturer is not liable for damages and their results, if they occurred due to improper assembly, operation, application and also inadequate maintenance and cleaning.**
- **Ensure that the burner is inserted to the proper depth of the boiler. Check this each time the burner is removed for cleaning or servicing.**
- **After installation, the exhaust must be tested with an O2 sensor by your dealer for flue gas analysis.**
- **Disconnect all electrical power to the boiler before performing any service, except when servicing the burner. There is a circuit breaker on the electrical box of the boiler that will shut off power to the burner, but will leave power to your pump, light and outlet.**
- **The water pump must run continuously whenever the WoodMaster Boiler is being used.**

# SAFETY



- **Never shut power off to the burner without allowing the burner to complete its shut down process unless there is an emergency.**
- **Take the proper precautions to ensure that the modifications made to an existing heating system does not interfere with existing safety controls.**
- **Never use the following: trash, plastics, gasoline, rubber, or naphtha in your WoodMaster Boiler.**
- **Read and follow these directions carefully. Retain this manual for as long as you own your boiler.**

## Sweeping

The chimney should be inspected and cleaned as needed, typically twice a year. This is to be done by qualified persons. Shut off the boiler and Renovator, disconnect power and allow the system to cool before attempting to clean the system.

## Warning!

Always disconnect the power to the boiler/burner before any cleaning or maintenance. Service agreements increases operation length and life of the unit. For more information contact your local WoodMaster dealer. Replacement parts should only be genuine Northwest Manufacturing, Inc. components. Your dealer can supply the genuine service parts and install them. They can then reevaluate the system and provide a flue gas analysis. Failure to perform a flue gas analysis may void your warranty.

## Safety Standards

**Guardian info: Solid Fuel Burner System. Listed by Guardian Fire Testing Laboratories Inc. Tested and listed to The Applicable Sections of UL-391, ETLM 78-1, ASTM-E 1509, UL2523 & CAN/CSA-B366.1 EPA EXEMPT PER 40CFR60.53A, METHOD 28A**

**AMSE H Stamp certified pressure boiler.**

<b>SOLID FUEL BURNER SYSTEM</b> Listed By: <b>GUARDIAN FIRE TESTING LABORATORIES, INC.</b>	
Make/Model: <b>WoodMaster/MB 30kw</b>	Serial No.: <b>MB30-XXXX</b>
Production Date Code:	
Manufacturer:	<b>Northwest Mfg., Inc. WoodMaster</b>
Test Date: <b>10/13/2014</b>	Electrical Rating: <b>6A, 120V, 60HZ</b>
	Fuel: <b>WOOD PELLETS, 10% MAXIMUM MOISTURE CONTENT. LESS THAN 1% ASH CONTENT</b>
<small>Tested and Listed to the Applicable Sections of UL-391, ETLM 78-1, ASTM-E-1509, &amp; CAN/CSA-B366.1, EPA EXEMPT PER 40CFR60.53A, METHOD 28A</small>	

Certified by Northwest Manufacturing Inc.	
MAWP. Water	<u>30</u> psi
Maximum Water Temp.	<u>250</u>
Heating Surface	_____ boiler
Heating Surface	<u>4432</u> water wall
Heating Surface	_____ extended
Ext HS generating cap	_____
Minimum relief valve capacity	<u>250</u>
Mfg. Serial No.	<u>MB30-XXXX</u>
Year built	<u>20XX</u>
	

## RENOVATOR PELLET BURNER

- Efficient heat from wood pellets that supports local economy.
- Generates Approximately 102,000 BTU.
- Automatic ignition for heat on demand.
- Air cleaned firepot to help keep maintenance to a minimum and retain high efficiency.
- Fully automatic PLC (Programmable Logic Control) for user friendly operation.
- Low maintenance.
- Built in burn back protection.
- Central electrical location for ease of wiring.
- Safety tested by Guardian to meet or exceed their standards for product quality & safety.



## BENEFITS OF THE MINI BOILER

1. Easy access ash door in front for quick and easy ash maintenance.
2. Large ash box for longer intervals between cleaning.
3. Efficient heat transfer tubes.
4. Easy access flue tube clean out door for simpler maintenance.
5. Water jacket with 10 gallon capacity.
6. Large Plumbing fittings on both sides of the boiler for easier installation.
7. Standard 6" flue pipe.

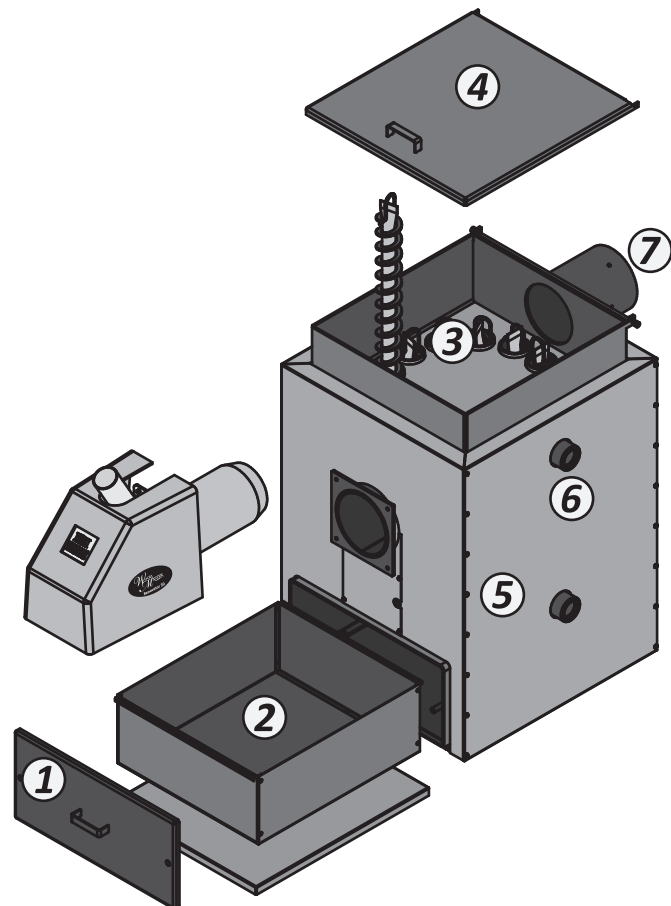

All wood pellets must conform to certain quality standards to ensure trouble free operation of the burner. Use of unapproved fuels may result in faulty operation and a voided warranty. Never use the following: trash, plastics, gasoline, rubber, or naphtha. Please contact your WoodMaster Dealer or Northwest Manufacturing, Inc. for any questions on fuel use.

## ***Pellet Specifications***

Only premium wood pellets certified by the Pellet Fuels Institute may be used and must follow these guidelines:

- Bulk density per cubic foot must be a minimum of 40 pounds
- The diameter is between 1/4 inch to 5/16 inch
- Maximum length is 1.5 inches
- Fines (dust) of not more than 0.5% by weight
- Sodium content shall be less than 300 parts per million
- Ash content of 1% or less
- Moisture content of 10% or less

**Note:** Pellets should be stored in a dry area and should not be allowed to get wet.  
Handle pellets with care.

**Note:** Each time you change brand/quality of pellets you may also have to change the start dose and feed rate of the burner.

Your WoodMaster Mini Boiler must be installed by a professional and should follow all local, state and federal laws and regulations. Any use of an unapproved installation may result in a voided warranty.

It is recommended to have your installation approved by WoodMaster. The Owner/Operator is responsible for operating the boiler in a manner that does not create a nuisance condition. WoodMaster requirements, state and local laws may not be sufficient in all conditions to prevent nuisance conditions due to factors that vary at each location. Please plan your system accordingly.

## Location

Your Mini Boiler can only be installed indoors. The Boiler may be installed inside the building that it serves or in an out building. Your Mini Boiler must have protection against freezing.

Ensure that the floor that the boiler is to be placed is level and able to support the weight of the boiler plus the additional weight of the water and fuel.

There should be ample room around your boiler to make loading and cleaning your boiler easier. This area should also be clear of any easily combustible materials. Minimum clearance requirements are 42 inches for the top, 18 inches for the sides, 24 inches for the back and 36 inches for the front of the burner when installed, with more space recommended at the front of the boiler to allow for more space when cleaning the boiler. Make sure to leave ample space on either side of the boiler for the hopper.

The room where the boiler is placed should allow ample venting to ensure proper air flow to the boiler. A minimum vent size of 31 square inches recommended.

Ensure the feet are in the bottom of the boiler. adjust the feet so the boiler sits level and the feet are loaded evenly.

Below are the dimensions for the WoodMaster Mini Boiler without the burner installed. The burner will extend approximately 16.25 inches from the mounting flange on the boiler. These dimensions are approximate.

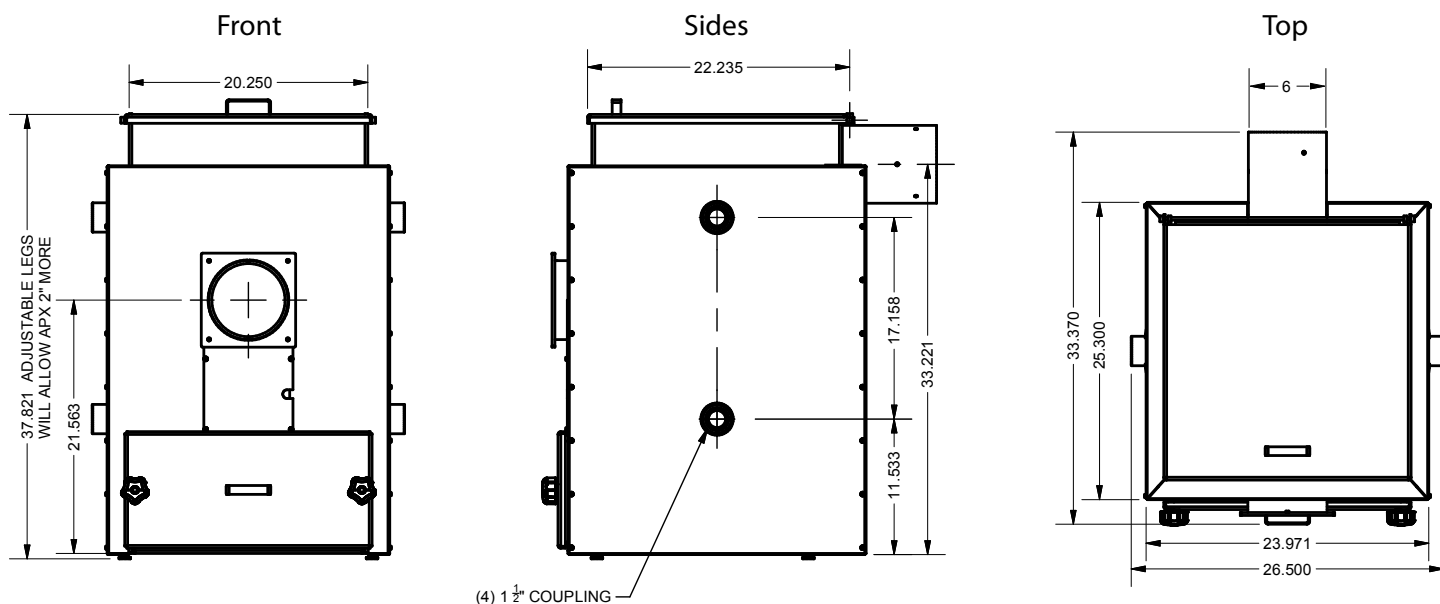



## Water Lines

The following layout is a basic configuration for the boiler water connections. Contact your WoodMaster dealer or Northwest Manufacturing for additional installation variations. Insulate the lines if desired to prevent heat loss. 1" oxygen barrier line is recommended. The boiler can be plumbed as a primary loop or a primary secondary loop.

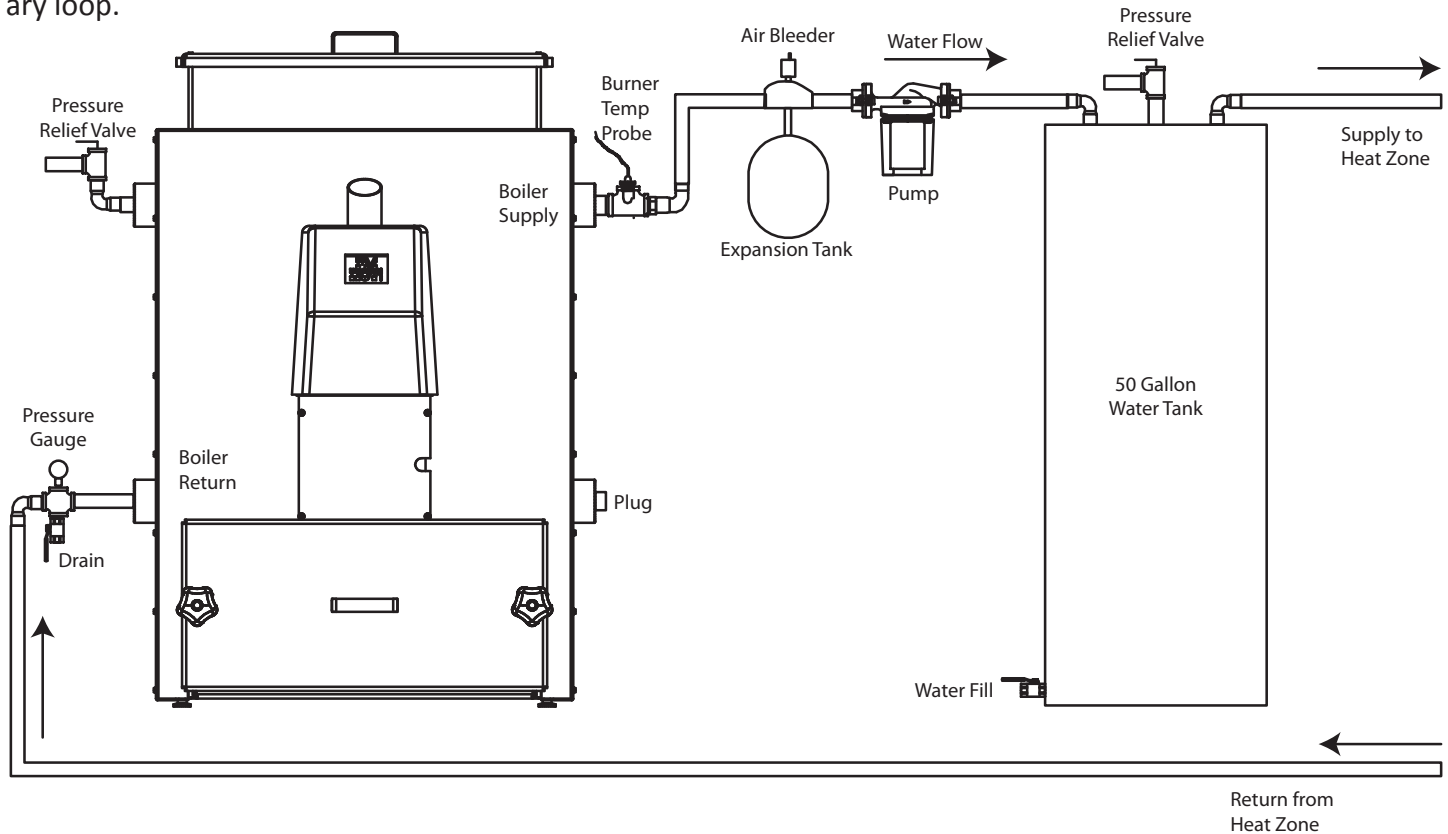

The WoodMaster Mini boiler is an ASME certified pressure vessel and is designed and tested to be used as a pressure vessel. Normal working pressure should be between 12 and 20 PSI, with a maximum working pressure of 30 PSI. Ensure that all lines and fittings used when plumbing the boiler are designed to be used in a pressurized system.

An expansion tank must be installed on the system along with an air bleeder. It is recommended to install a pressure relief valve on the boiler, and one on the water tank. These can also be used to bleed air out of the system when filling with water. A pressure gauge should also be installed on the boiler.

When plumbing the boiler, the boiler supply should be on the top of the boiler on either side, and the return must be on the bottom of the opposite side. The supply and return CAN NOT be installed on the same side of the boiler. Having the supply and return on opposite ends of the boiler allows for proper water circulation within the boiler.

The pump that circulates the water through the boiler must have a flow of 10-12 GPM and the target temperature difference between the supply and return is 20 degrees Fahrenheit.

**WARNING: Do Not install close off valves on the boiler loop, closing of the loop while in operation can create dangerous conditions. Follow all state and local codes for installing a pressurized system.**

### **Filling With Water**

Connect a garden hose or other supply line between a domestic water supply and the bottom of the water tank. Slowly fill the tank first, venting the air out of the tank through the safety relief valve installed on the top of the tank. Once the tank is full, close the relief valve on the tank and open the relief valve on the boiler. When the boiler is full, shut off both the water supply and the relief valve. Turn on the pump to circulate the water and to push the air out of the system. Add water to the system as needed.

Routinely check to the water pressure level. If the pressure is out of range, add or remove water as needed. The Use of boiler treatment is recommended.

**The following examples are for a primary loop as a secondary heat source.**

### **Domestic Hot Water**

The Domestic Hot Water/Flat plate Kit consists of a Water to Water Heat Transfer unit and the fittings needed to hook it up. The unit mounts on the wall **VERTICALLY** in your utility room and is connected as shown.

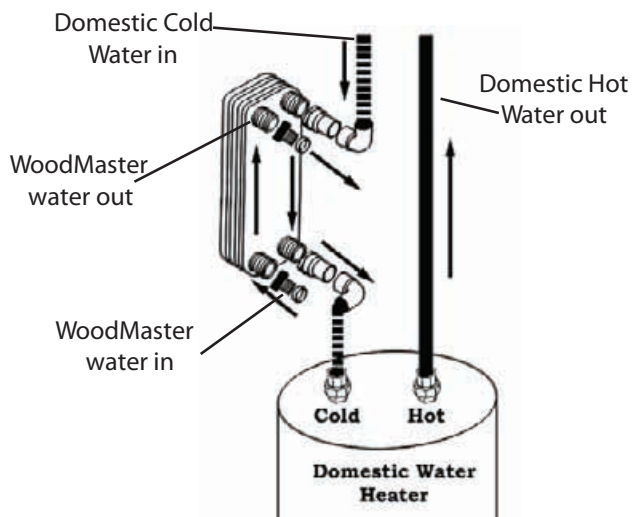

### **Existing Forced Air**

A water to air heat exchanger is inserted in the existing plenum. In most cases the heat exchanger is placed in a horizontal position, keeping all four sides level. The air must be forced through the finned area of the heat exchanger evenly. The hot water line coming from the hot-water tube enters the bottom fitting of the heat exchanger and exits the top fitting, which returns to the boiler. If the plenum is too large or too small, it must be altered to fit the heat exchanger properly.

**Note: The water to air heat exchanger must be installed below any existing off-peak electric coils already in the plenum.**

After the installation of the WoodMaster add-on water to air exchanger, the air flow may need to be increased to fuel boilers, electric boilers, and electric/gas boilers. Methods of doing this are:

### **Belt Drive System**

Blower pulleys and motor pulleys may be changed but the electric current flowing through the motor shall not exceed the nameplate rating. (A blower motor of larger power may be used.)

### **Direct Drive System**

The motor shall not be changed, however the speed of the motor may be increased.

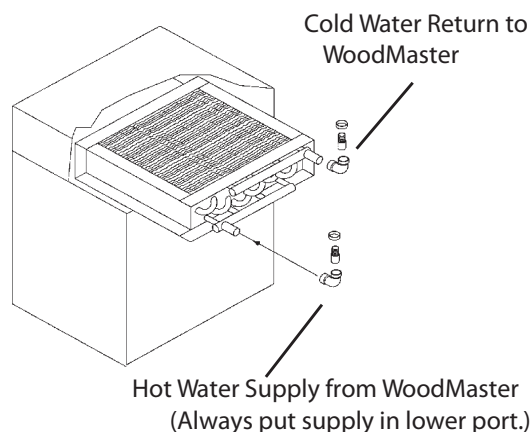

## Existing Hot Water Heat

A Water to Water Heat Transfer Unit (0020-052) is used to connect to an existing hot water boiler system.

**Note: Any changes that are made to an existing boiler should be done by a qualified plumber and follow all state and local codes.**

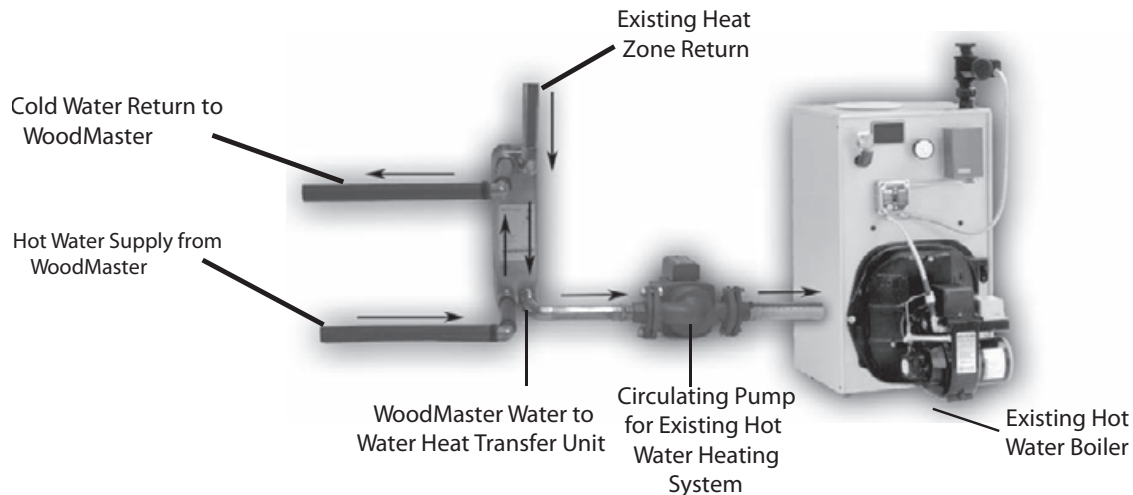

## Chimney

- The flue pipe to be installed can be a rising chimney or a power vent, as long as the following conditions are met. The flue gas outlet on the boiler is a standard 6" Pipe.
- Elbows can be used, but T's are recommended to allow for the cleaning of the flue pipe.
- For every one foot of horizontal pipe three feet of vertical pipe is required on a rising chimney.
- Flue pipe should be insulated. Non insulated sections are not recommended.
- A draft controller should be used to allow proper flow. The draft controller must be installed as close to the boiler as possible.
- A draft inducer may be used to ensure proper draft.
- The chimney draw must be between -.45 and -.30 mbars (-.18 and -.12 inches of water).
- The chimney must follow all state and local codes.
- The chimney should be installed by a qualified professional.
- The chimney must be externally supported.
- The chimney can not service any other appliance.

## Wiring

**Note: Be sure to follow all local, state and federal guidelines. Wiring installation should be preformed by a qualified electrician.**

Your Mini Boiler needs a 120 V connection with a 15 amp circuit for the basic unit. The unit must be properly grounded to ensure proper operation. Failure to properly ground the unit will result in a voided warranty. See the wiring diagram at the end of the manual for more information. Connect the pump to a independent, grounded power source.

## *Renovator Pellet Burner Installation*

Install the mounting bracket to the boiler with the supplied hardware. The holes on the frame are slotted to allow adjustments for proper alignment. Use fiberglass rope or similar material to create a gasket between the boiler mounting plate and the burner mounting bracket (a gasket may have already been installed at the factory). Leave the bolts loose to allow for adjusting when installing the burner. There is a set screw on the ring of the bracket to lock the burner in position. The set screw can be positioned on the top or on either side.

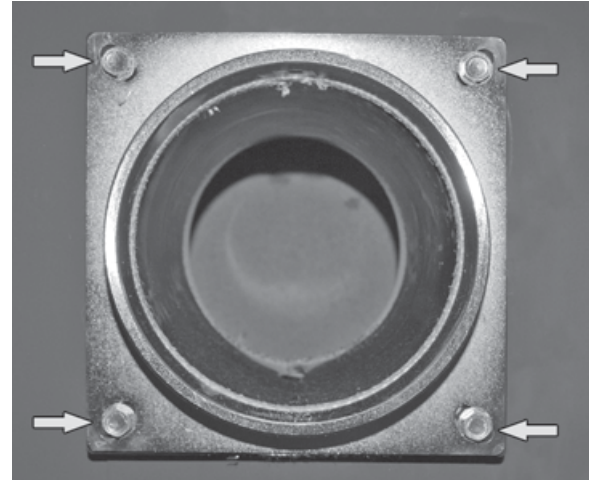

Remove the red cover from the burner. Insert the burner into the bracket. Do not install the burner to the maximum depth. Leave a 1.5 inch gap between the mounting bracket and the body of the Renovator. Tighten the four mounting bolts, then make sure the burner is level, and tighten the set screw, being careful not to over tighten.

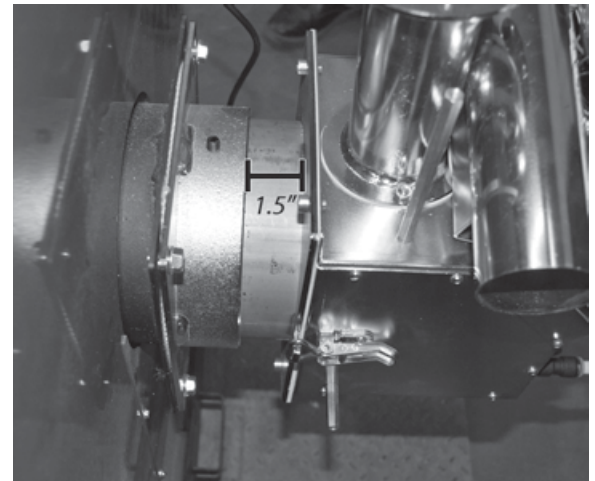

Attach the tipping chute to the burner in the desired position with the supplied thumb screws. The tipping chute can be installed in multiple directions to allow for the pellet hopper to be placed on either side of the boiler.

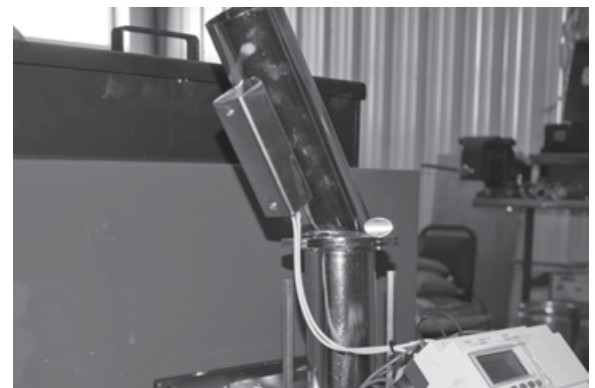

# INSTALLATION



## **800 Watt Igniter Wiring**

800 watt igniters need a dedicated 120v power source, that is routed through a relay on the side of the combustion fan. **NOTE: Disconnect all power during installation.**

The black wire from the igniter is already connected to the relay, along with two wires from the PLC. There should be one open location on the relay; this should be connected to the black wire from a 120v power source.

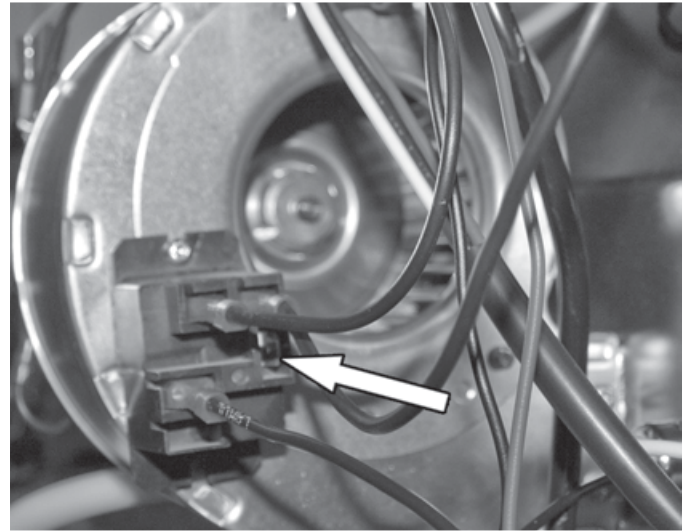

The white wire from the burner should be connected to a white wire from a 120v power source. See the wiring diagram for complete wiring of the burner.

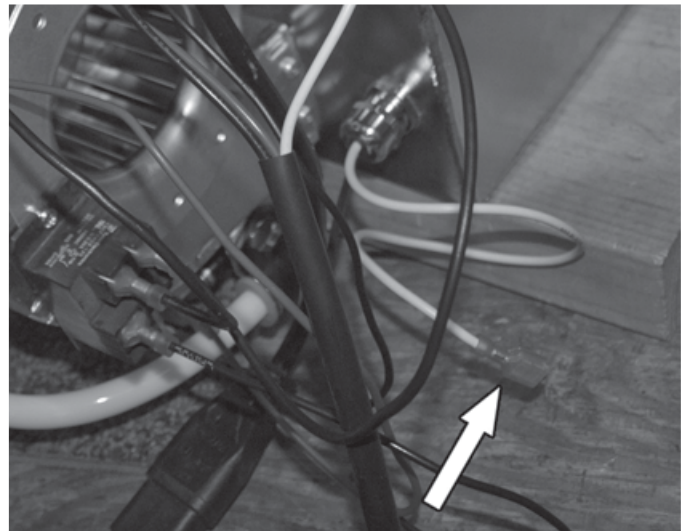

Place the cover over the burner and secure it in place using the four thumb screws provided.



Connect the wires to the burner. The Renovator Pellet Burners have very simple connections that allow for easier removal for cleaning and maintenance.

- A. Power Switch
- B. Fuse
- C. Power lead in
- D. To feed auger
- E. To Temperature Sensor

The protective cover on the burner cannot be removed without disconnecting these cables.

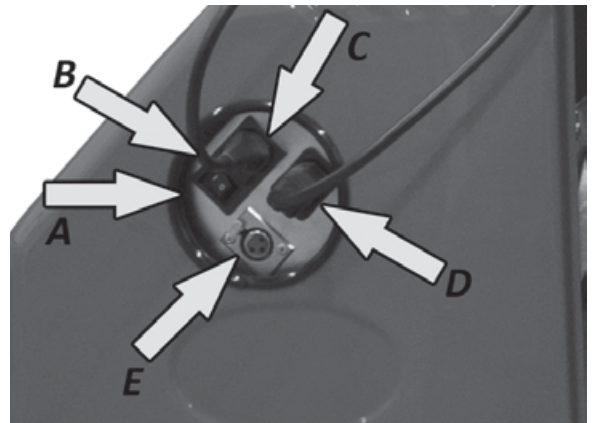

Install the probe in a well on the supply line next to the boiler. Make sure the probe set screw contacts the metal of the probe. **DO NOT** clamp the probe by the wire, this will damage the probe. Contact paste can be used to increase the accuracy of the probe.



## **Feed Auger Installation**

The angle of the auger should be between 43 and 45 degrees. The auger can be hung from the ceiling or overhead support with a chain. The feed auger should be placed so that it does not sit right above the tipping chute on the burner. This helps reduce potential damage in the event of a burn back. The auger pipe is 51" in length and the spiral is 65.75". No modifications to the length of the components can be made.

1. Attach the auger spiral to the motors output shaft. Push the spiral as far as it can go onto the shaft, then pull it back approx. 3/8" to prevent binding. Clamp the spiral in place by tightening the two bolts that hold the clamp in place. *Note: The auger head may have a slightly different appearance than the one shown in the pictures. Assembly of the auger will not change.*

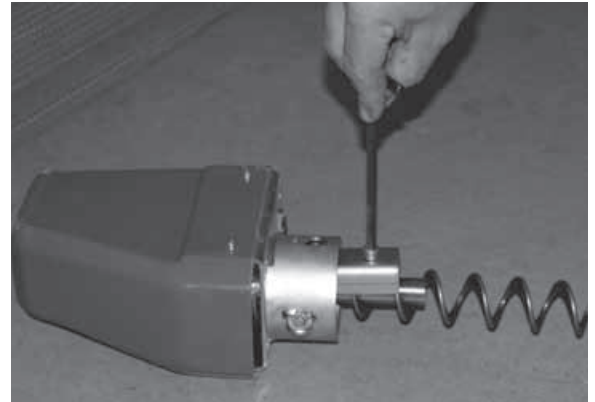

2. Slide the T-pipe onto the auger tube and fasten them together using the screw provided indicated by the arrow. Do not use a longer screw for this fitting.

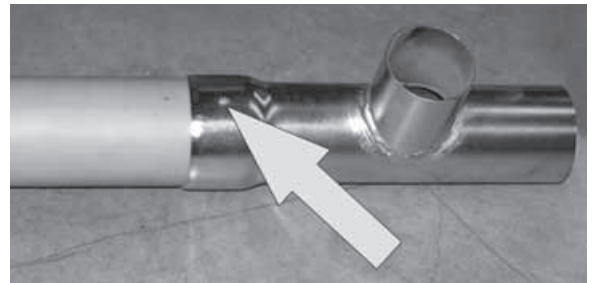

3. Push the auger pipe over the spiral. Make sure the outlet of the T pipe is pointed in the direction shown.

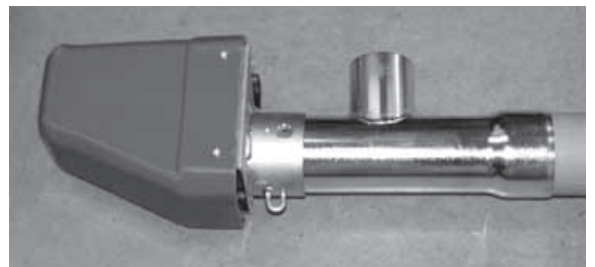

4. Fasten the screw shown to lock the auger pipe in place.

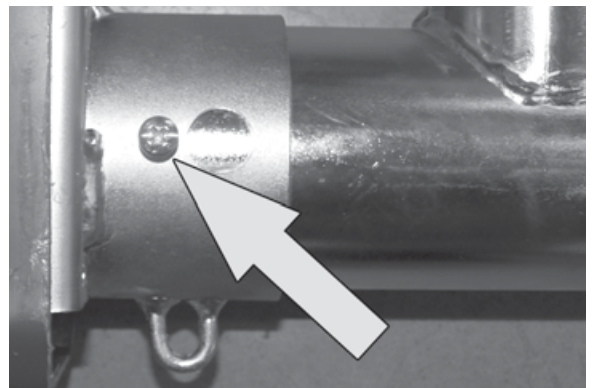

5. Slide the inlet pipe over the auger tube. The hole in the inlet pipe should be 180 degrees towards the outlet on the T-pipe.

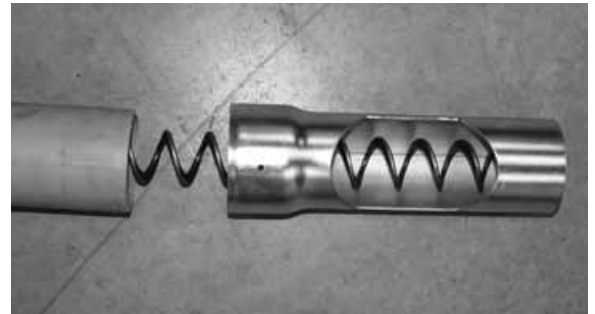

6. Fasten the screw shown to lock the inlet pipe in place.

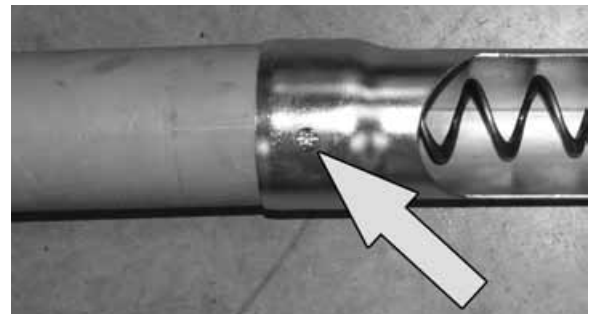

7. Slide the blue tube to the outlet of the T-pipe, and the cap on the end of the inlet pipe. The auger is now ready to be installed.



### ***Poly Pellet Hopper Assembly***

The optional pellet hopper holds approximately 280 pounds of pellets. Northwest Manufacturing, Inc. recommends using our pellet hopper to ensure proper fuel flow and to protect the pellets from the elements.

1. Lay the hoppers main body on it's side and attach the legs by inserting the bolts and securing them on the inside of the hopper body with the supplied hardware.





# INSTALLATION



2. Stand the side hopper upright. Attach the leg supports ensuring that the longer of the three supports is on the side of the hopper that faces the boiler.

**Note: Install the supports on the inside of the legs, securing the supports to the legs with the “U” bolts. DO NOT TIGHTEN THE “U” BOLTS AT THIS TIME!**



3. Attach the boot to the bottom of the side hopper. Do not tighten the clamp on the boot at this time.



4. Put the top on the hopper by securing the hopper top to the side hopper with the screws (6) provided. Place the hopper in its location next to your Ultra Series boiler.



5. Secure the boot to the intake auger tube with the clamps provided. Apply the bottom boot to the end of the intake auger tube and secure it with the clamp. Tighten the clamp on the boot to secure it to the side hopper. Apply a bead of silicon between on the auger tube next to the inlet pipe and boiler panel to seal out water and snow.



6. Raise the leg supports to a point just below the intake auger tube. Tighten the “u” bolts on the leg supports to secure the legs to the leg supports. Fill the side hopper with wood pellets and prime the auger following the directions on page 20.



### **Metal Pellet Hopper Assembly**

The optional pellet hopper holds approximately 280 pounds of pellets. Northwest Manufacturing, Inc. recommends using our pellet hopper to ensure proper fuel flow. Each part is numbered on the chart on the next page for reference.

Install the adjustable feet into each of the four legs of the hopper.

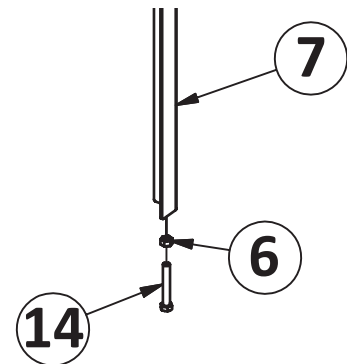

Assemble the four side walls out of side skins 12 and 10. Use the hopper side seam 11 to join the skins together using the provided screws.

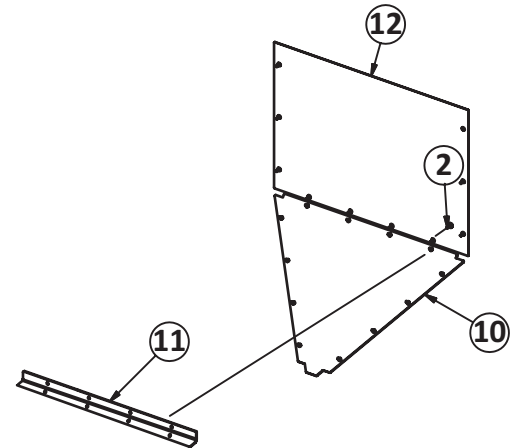

Join the assembled side walls to the legs using the supplied screws. The legs will be on the inside of the hopper, with the skins screwed to the outside.

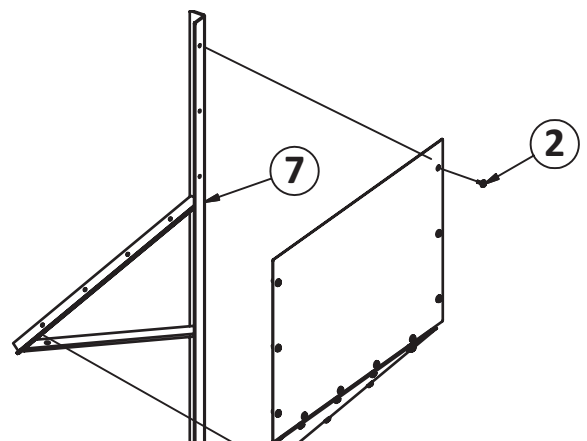

# INSTALLATION



Place the lid of the hopper on the hopper when assembly is complete. DO NOT remove during operation.

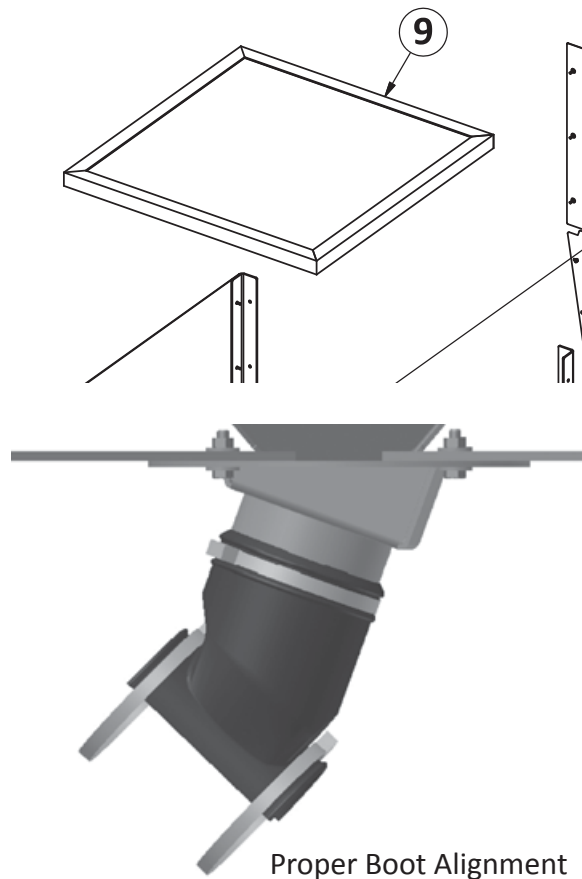
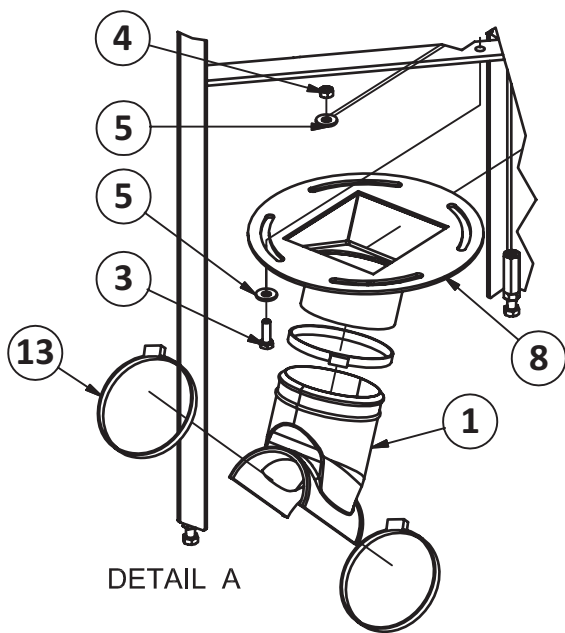

Once the hopper is assembled put it in place next to the boiler. The bottom is adjustable to allow for easy installation of the auger tube. Assemble the bottom by securing the hopper boot to the adjustable bottom with a hose clamp. Using the provided bolts and washers secure the bottom to the braces on the legs, do not tighten the bolts until the auger is in place to allow for adjustments.

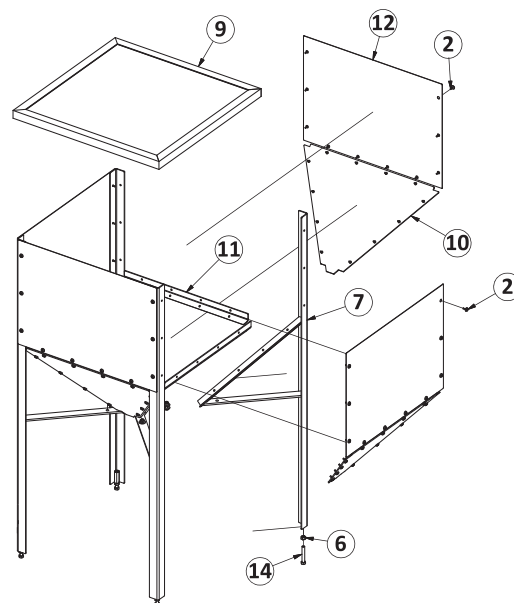

## ***On Board Air Cleaner Installation***

The Renovator Pellet Burner has the capability to clean the fire pot with compressed air supplied by an on board air compressor. This allows for easier ignition as well as lower maintenance. Below is a brief explanation of the installation process. **NOTE: Disconnect all power during installation.**

1. Disconnect the wiring and remove the plastic cover of the burner. **Note: The burner does not need to be removed from the boiler to perform this installation, the burner is shown off the boiler for reference only.** The location of the air line connector is below the combustion fan on the left side. Connect the supplied air hose to the air line connector on the burner.

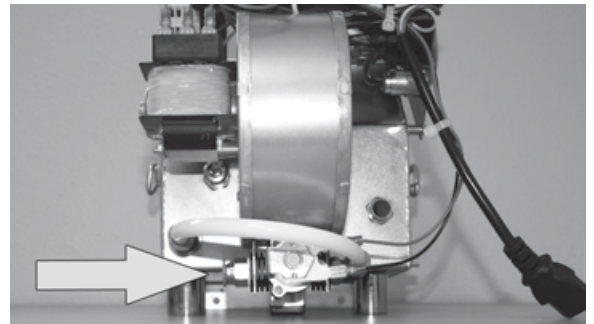

2. Unpack the air compressor. Connect the adaptor fitting to the outlet of the air compressor. **NOTE: Thread sealant must be used in this connection.**



3. Connect the quick connect elbow to the adaptor fitting that you just installed on the air compressor. **NOTE: The threads on the quick connect elbow will already have thread sealant applied.**

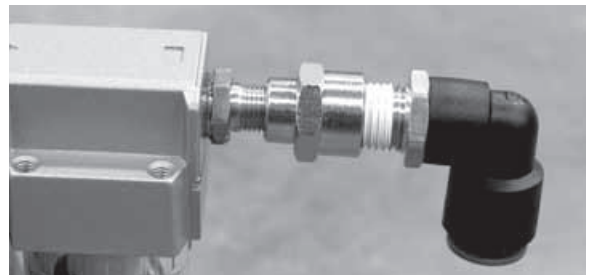

4. Place the air compressor next to the boiler, making sure the air line and power cord are clear of the ash door and other heat sources.



# INSTALLATION



5. Connect the air hose to the air compressor via the quick connect. Make sure the air compressors power switch is left in the “on” position. **NOTE: Do not modify the length of the air hose.**

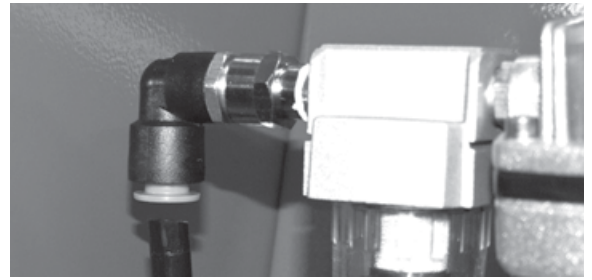

6. Plug the supplied air compressor power cord adaptor into the burner. Plug the air compressor power cord into the adaptor. Replace the burner cover.

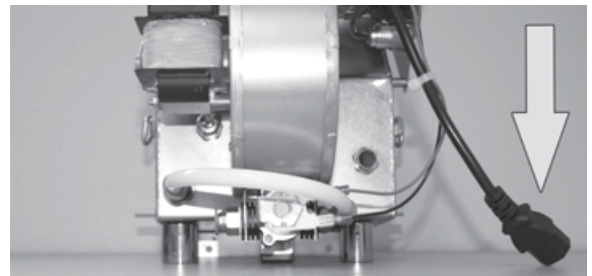

If you do not wish to use the on board air cleaner, you still need to supply compressed air to the burner for cleaning. Northwest Manufacturing, Inc. offers an adapter (Part Number: 0020-213) that will allow you to connect the air hose to a full size air compressor. Whenever the boiler is operational there needs to be a constant supply of compressed air of 80-90 psi available to the burner.

## **Priming the Auger**

Make sure the auger tube is not connected to the burner chute. Connect cable of the auger with the power cable for the burner and run it manually until pellets fill the auger. Once pellets start to fall out of the end of the auger, run for an additional 3 minutes to ensure the auger is completely full. We recommend that you run the auger three times manually for 70 second intervals and then weight each dose to see if the auger gives an even feeding. Insert the auger tube into the tipping chute when complete.

## **Flue Gas Analysis**

Once the boiler is installed, it must be adjusted to proper burn settings. The sensor should be placed in the sensor access port on the boiler chimney, directly above the tube access box and below the draft inducer. These setting will vary slightly depending on variables in fuel quality. A flue gas instrument analyzer must be used to properly adjust the burner. **NOTE: Make sure the flue gas instrument used supports biomass fuels, otherwise damage to the instrument may occur.** The target value for oxygen that you are trying to reach is: O<sub>2</sub>: 6-10.5%, with The Ideal target being between 6% and 8%.

### **NOTE: THE Boiler AND CHIMNEY WILL BE HOT DURING THIS TEST!**

the O<sub>2</sub> value is the average over a one hour continuous burn. The value will fluctuate slightly during the duration of the burn. It is recommended to wait 3-5 minutes between adjustments to give the burner time to react to the adjustments. Shorter on/off time intervals will result in a more even and efficient burn. When adjusting to the oxygen level, if the O<sub>2</sub> level is below the target values, less fuel is needed, if it is above the target values, more fuel is needed.

**Note: The boiler should be readjusted each time a new brand of pellets is used.**

The burner is not adjusted from the factory. The burner has to be adjusted with a flue gas instrument the first time the burner is fired and after a change in fuel brand/quality.

1. Remove the blue hose from the burner prior to priming the feed auger. Connect cable of the auger with the power cable for the burner and run it manually until pellets have been fed out from the auger for about 15 minutes using a bucket or pail to catch the pellets. Insert the tube adaptor into the tipping chute when complete.
2. Setting of screw on (the amount of pellets at ignition). A good start dose is approx. 150 grams (5.25 ounces) We recommend manually measuring the start dose. The start dose is approx. equal to the volume of an 8.5 oz cup.
3. To adjust amount of fuel for operation, a flue gas instrument must be used. The proper adjustment is needed to obtain the cleanest and most efficient burn. This should be made by your authorized WoodMaster Dealer.

### **Programming and information about the PLC control**

To make changes to the settings of the PLC, use button 1 to scroll between menus. Once you have found the menu with the setting you wish to change, press the white button on the right with button 4.

Once the white button and button 4 have been pressed one of the values that can be changed is now blinking.

**Note: In cold temperatures, the blinking may not be visible due to screen delay caused by extreme cold.**

To change the desired value, adjust with buttons 2 (down) and 3 (up).

Buttons 1 and 4 let you scroll between the different settings on each menu.

Press the menu/ok to save any changes made. The value should stop blinking.

**1.** This is the default home screen. No changes can be made in this menu. Pressing the white button and the Menu/Ok button will briefly change the display to show the date/time screen. This will change back on its own.

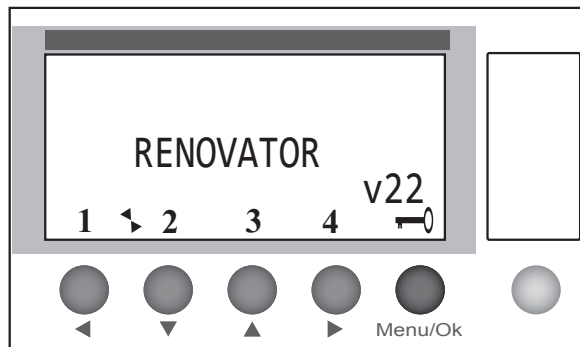

**2.** In this menu you can set the screw on time. Here you choose how many seconds the auger takes to feed the optimal start dose (approx. 150 grams or 5.25 oz) of fuel pellets. This menu also handles the desired value of the photo sensor that controls the flame at combustion. When the sensor sees the flame has reached input value the burner switches to the soft start in the combustion phase. The photo sensor value can also be read in real time. **NOTE: DO NOT open the doors during operation.**

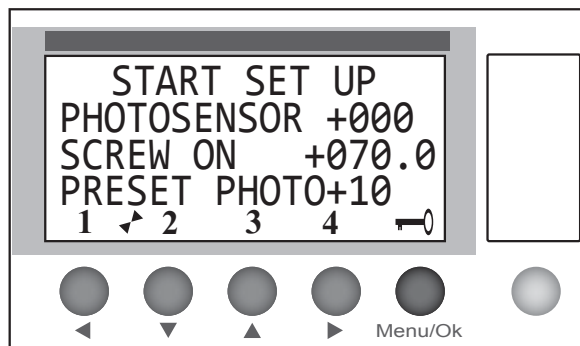

# OPERATION



3. In phase two, the soft start level, the auger feeds the burner 5 times with three second operation intervals on the auger before it goes over completely to full burn mode. The three values in this menu can be changed.

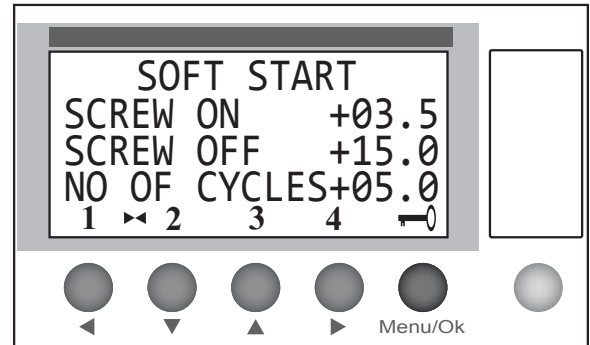

4. The next menu shows the mode the burner, as well as the approximate input power. This menu allows you to change the auger run times, as well as the burning mode. Only make adjustments to the burner when a flue gas analyzer is being used to attain a proper burn. The feed rate can only be adjusted in LOW and HIGH modes, see step 5 for adjusting AUTO mode in which the PLC determines the burn rates. To change modes, do not press button 4 and the white button. Instead, simply press buttons 2 and 3 together to change the burning mode.

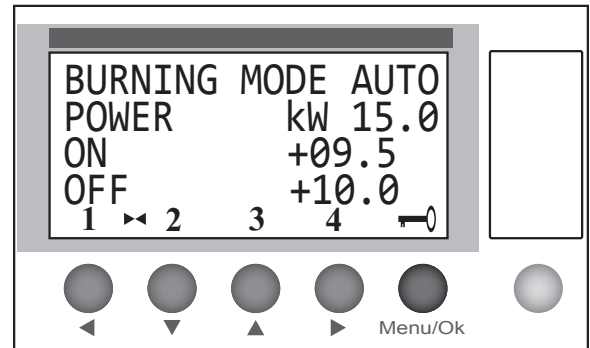

5. The Startdos value in this menu (this is a different setting than the start dose previously described) is adjustable between 100 and 400 grams and is the adjustment used when the burner is in Auto burning mode. The MAX RUN-TIME value is how long the burner will run before shutting down to self clean. The default value shown is 3 hours. If heat is still called for, the burner will restart after the cleaning is completed. You can also read the operation time of the burner and how many times it has started.

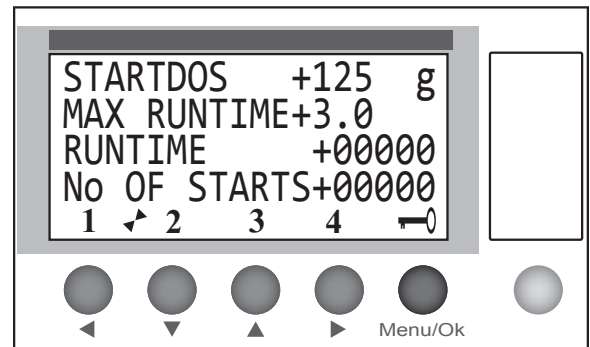

6. This menu displays the current temperature of the boiler under the BOILTEMP value. The START and STOP values are user controlled to set the desired hysteresis for the burner. This menu will only appear on units programmed for a boiler installation. **The recommended values are 135° for the start temperature and 180° for the stop temperature. Higher temperatures may cause damage to the boiler.**

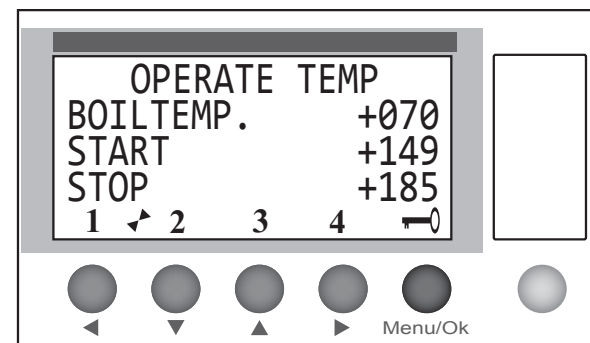

**7.** The PLC also keeps track of some faults that could be useful to in the event of a problem occurring. This history shows how many ignition errors, fuel errors and if the burner has overheated via the temperature sensor that is placed on the tipping chute. There are no values that can be changed in this menu.

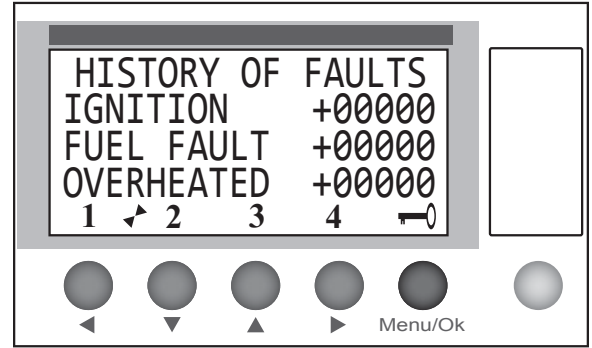

### Alarm (The display shows a message and the burner has turned off.)

**8.** This alarm example indicates an error has occurred to the sensor that controls the boiler temperature. **Do not attempt to start the burner.** Turn off the burner and check the connections for the sensor. Restart the burner. If the problem persists, contact your dealer or Northwest Manufacturing, Inc.

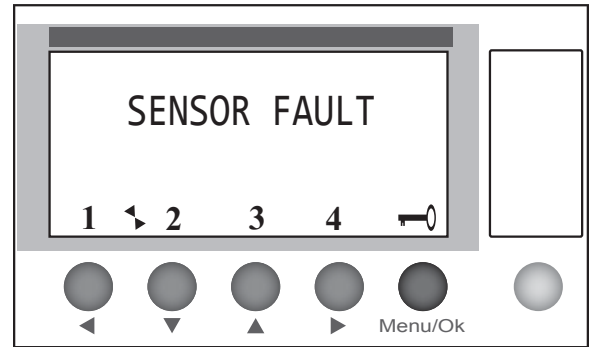

**9.** When this alarm appears the pellet hopper is empty. Please refill the pellet hopper with pellets. This will only appear if you have set up a level sensor in the pellet hopper. If you do not have a level sensor in the pellet hopper, then a FUEL FAULT will occur. See the troubleshooting section for further assistance.

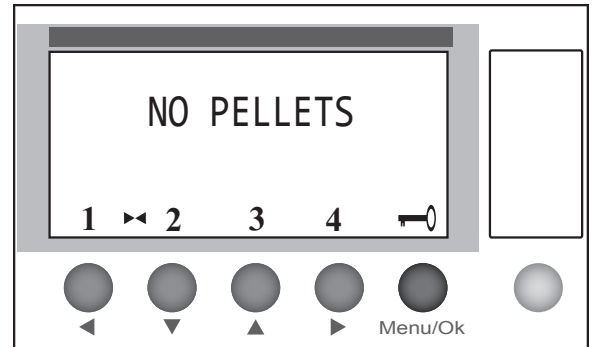

**10.** When this alarm appears on the burner turn the power off to the burner once the combustion fan has stopped. Allow the boiler to cool and clean the boiler. Check the heat exchanger tubes and clean if they are dirty. Turn the burner back on and reset it. To reset the burner hold down button 4 until the PLC is reset. If the problem persists, there could be a lack of proper draft. Contact your dealer or Northwest Manufacturing, Inc. or see the troubleshooting section for further assistance.

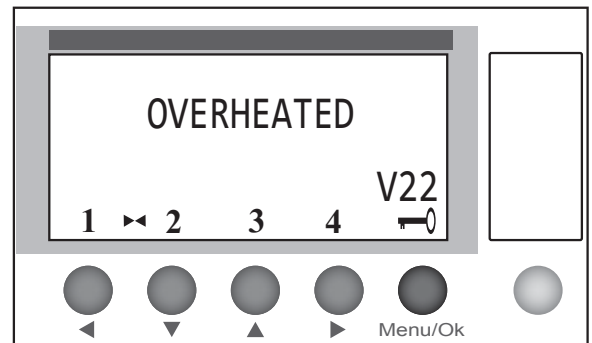



**11.** Error on the ignition element. This may be caused by an incorrect start dose, a dirty burner or a failed igniter. Turn off the burner and restart. Check to make sure you have the correct start dose settings, or check the connection for the feed auger. If the burner starts, no further action is needed. If not see the troubleshooting section for further assistance. If the problem persists or if the igniter is bad, contact your dealer or Northwest Manufacturing, Inc.

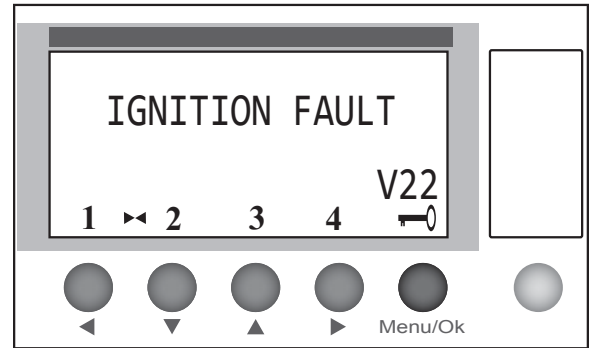

**12.** The error “FUEL FAULT” can be displayed for multiple issues:

1. Make sure there are pellets in the pellet hopper.
2. Make sure that the auger drive motor is working by connecting the power cord of the burner and the power cord of the auger.
3. If the pellet hopper is empty it is best to fill and run the auger until pellets come again manually. Let the auger run for approx. 10 -15 min to get an even dosage.
4. Make sure the pellets in the pellet hopper are not cavatating. If this is occurring, clean the pellet hopper.

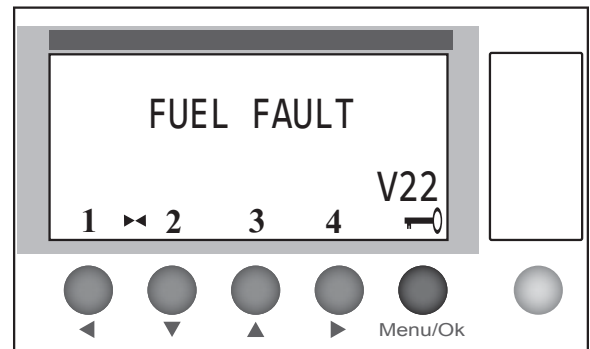

If the problem persists, contact your dealer or Northwest Manufacturing, Inc. See the trouble shooting section for further assistance.

### **13. Shutting the Burner Off**

When shutting off the burner, either for maintenance or for the season, the burner must be allowed to enter and complete its shutdown process. Failure to allow the burner to shut down properly can result in damage to the burner, especially if done repeatedly. It will also greatly reduce the burners efficiency. If the burner is idle and the combustion fan is off, the burner can be switched off.

If the burner is running, the STOP set point on the operation temp screen should be adjusted so that it is lower than the current boiler temperature. This will initiate the burners shut down process. Once the burner has air cleaned and the combustion fan has turned off, the burner can be switched off. This process will take approximately five minutes.

*Note: You should clean the boiler on an “as needed” basis, typically once a week. Not all wood pellets burn the same, some may require you to clean the boiler more frequently. Your warranty does not cover ash corrosion. The boiler must be completely cleaned of ash and creosote at least twice a year, including at the end of the heating season. Neglecting to clean your boiler or cover the chimney when not in use, will void the warranty.*

**WARNING:** Before performing any of the following tasks, ensure that the power is disconnected from the boiler and the burner, and that all components of the system have had ample time to cool.

### **Removal and Cleaning of the Burner (Monthly)**

Disconnect the cables on the side of the burner.

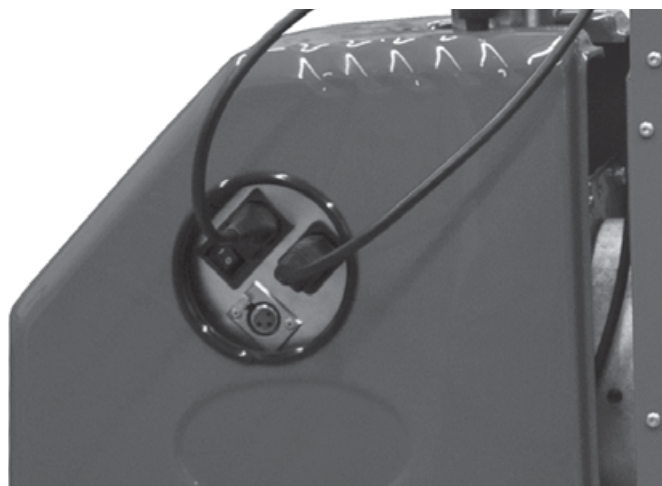

Remove the four thumb screws that hold the cover on the burner. Remove the cover.

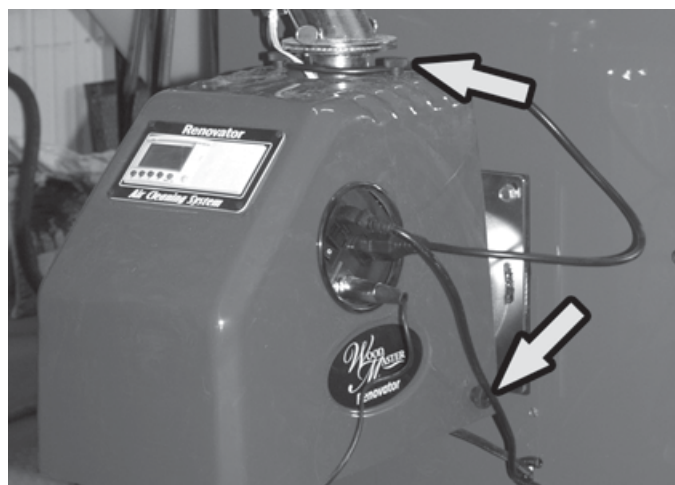

# MAINTENANCE



Disconnect the red air line from the air compressor by pushing in the blue collar on the fitting, while pulling out on the hose.

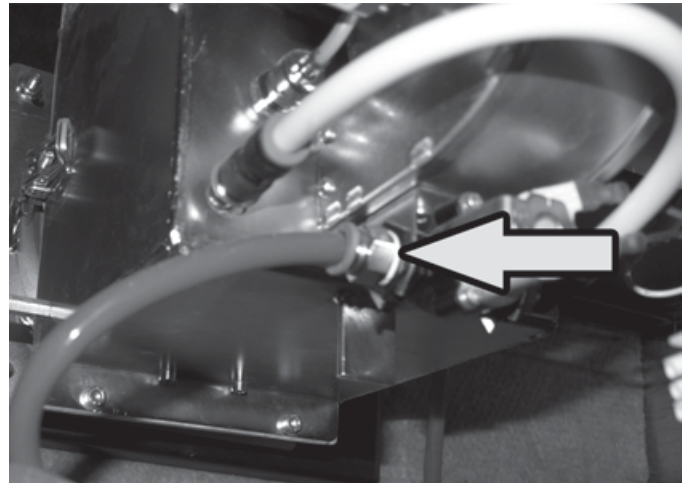

Disconnect the white wire for the igniter, and remove the black igniter wire from the relay on the side of the fan. Disconnect the wires by pulling on the connectors. Pulling on the wires will damage the connectors.

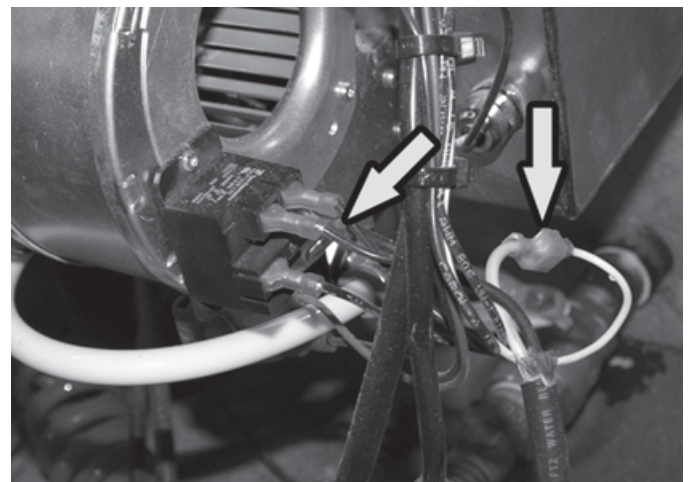

The burner can be removed in two different ways. The first example removes the entire burner from the furnace and should be done yearly for a full inspection and cleaning. The second way leave the burner tube installed and allow for easier access to the burn pot for routine cleaning.

## ***To completely remove the burner:***

Remove the set screw from the mounting flange.

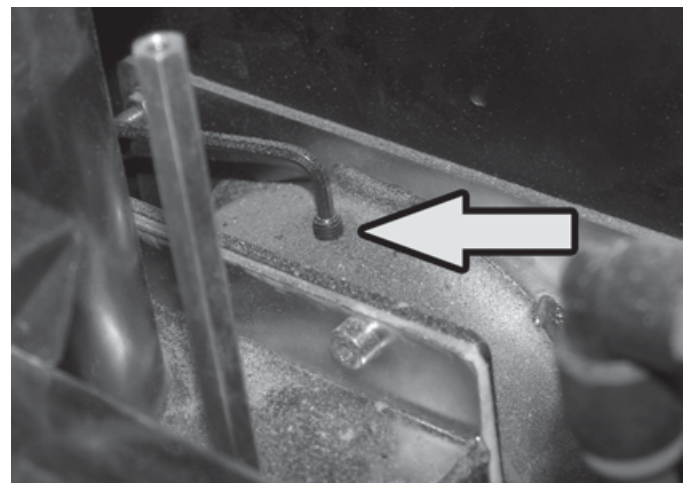

Carefully slide the entire burner assembly out of the firepot.

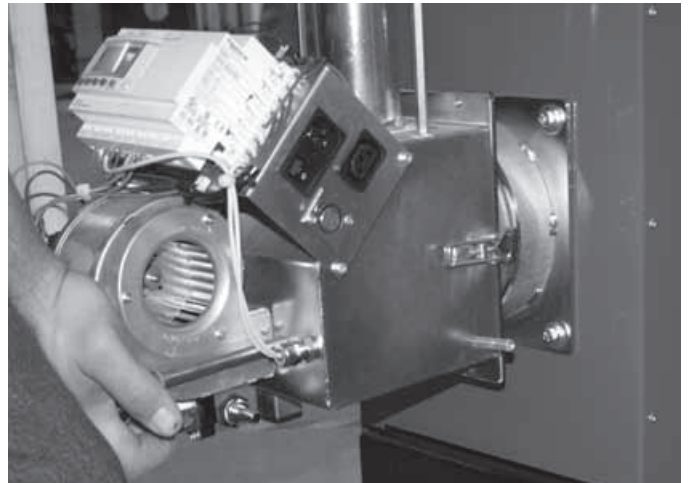

Release the quick latches that hold the sections together. Be careful as to not damage the gasket between the sections.

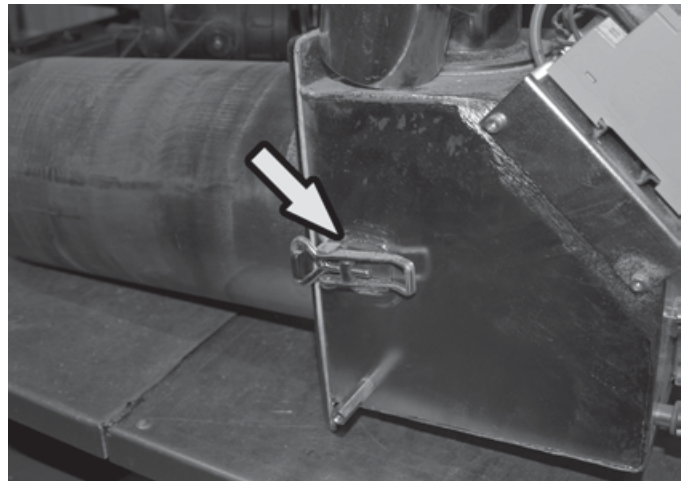

Slide the inner part of the burn pot out of the outer sleeve.

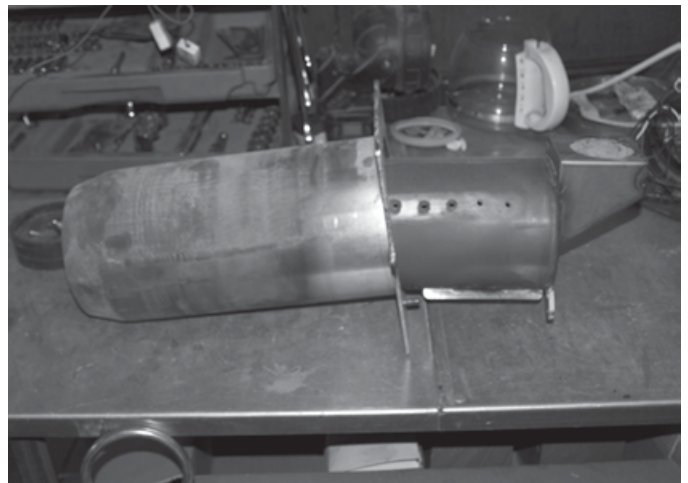

# MAINTENANCE



Clean any buildup out of the burn pot, and clean all debris out of the air holes.

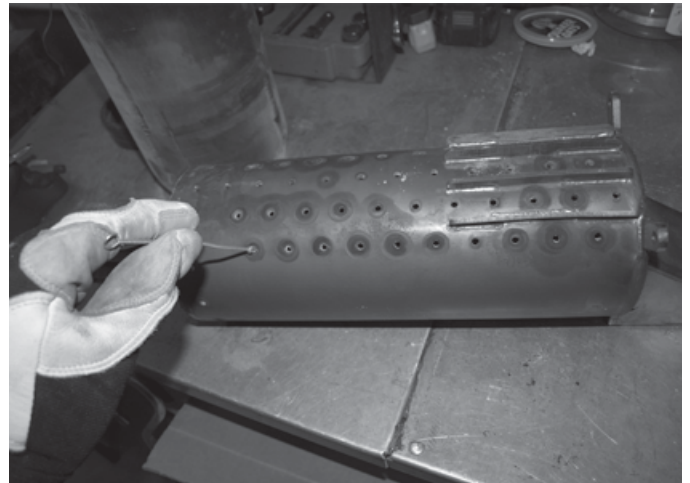

Once clean, insert the inner part of the burn pot into the outer sleeve. Ensure the alignment pins line up.

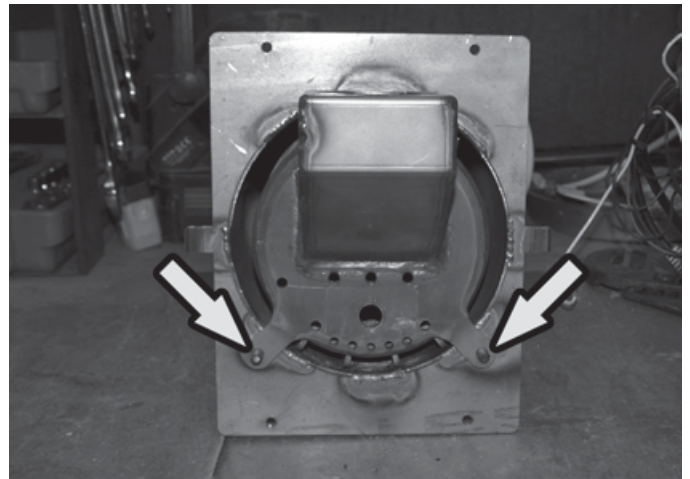

When reassembling the burner, line up the four alignment screws that align the sections together with the gasket in place. Then latch the quick latches.

Repeat the reset of the removal process in reverse to reassemble the burner.

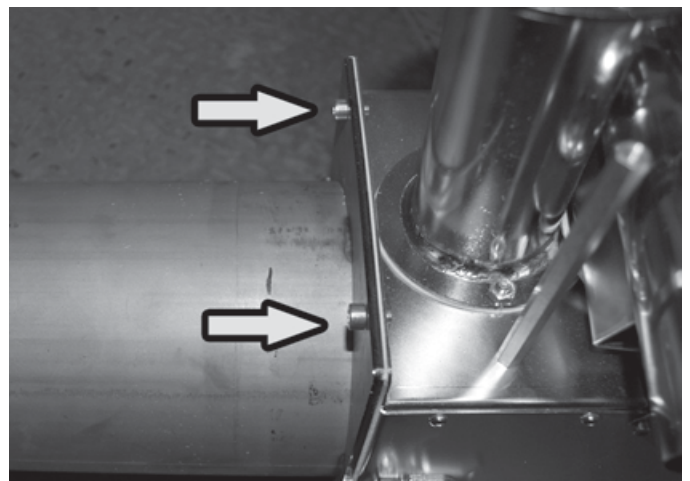

***To partially remove the burner:***

Release the quick latches that hold the sections together. Be careful as to not damage the gasket between the sections.

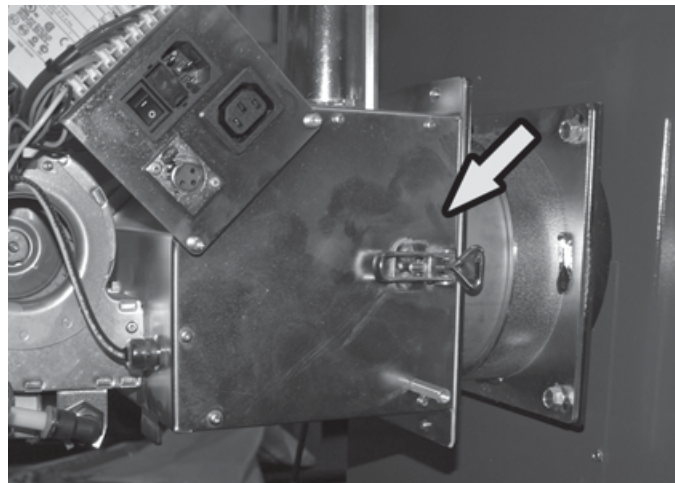

Slide the inner part of the burn pot out of the outer sleeve.

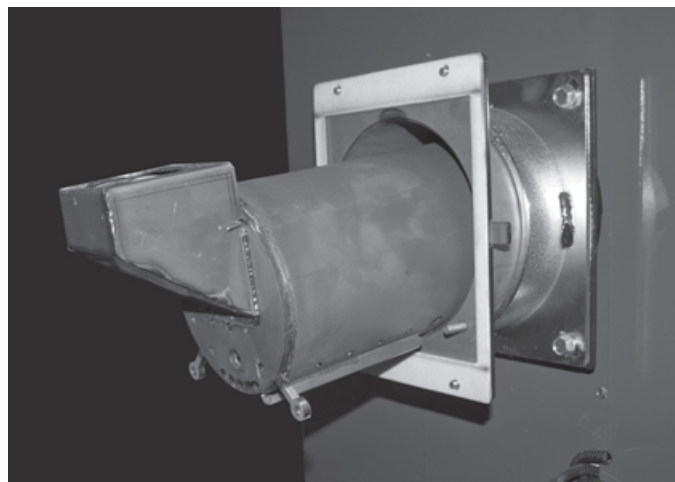

Clean any buildup out of the burn pot, and clean all debris out of the air holes.

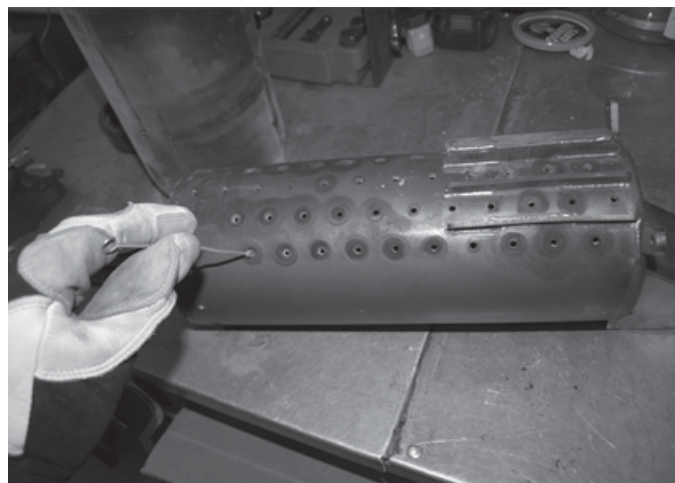

# MAINTENANCE



Once clean, insert the inner part of the burn pot into the outer sleeve. Ensure the alignment pins line up.

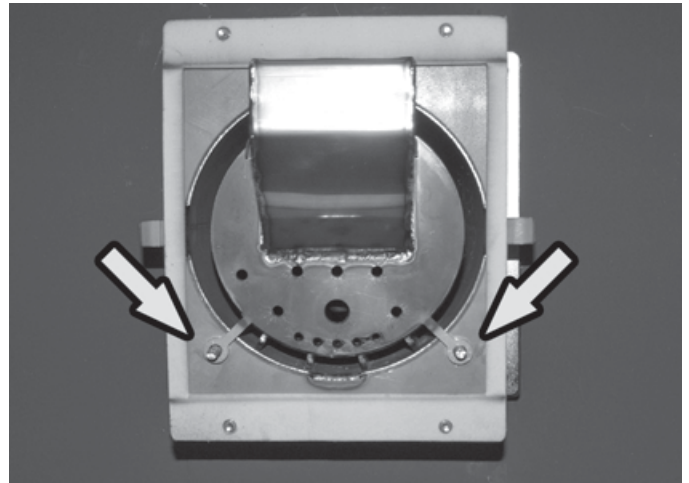

When reassembling the burner, line up the four alignment screws that align the sections together with the gasket in place. Then latch the quick latches. Repeat the reset of the removal process in reverse to reassemble the burner.

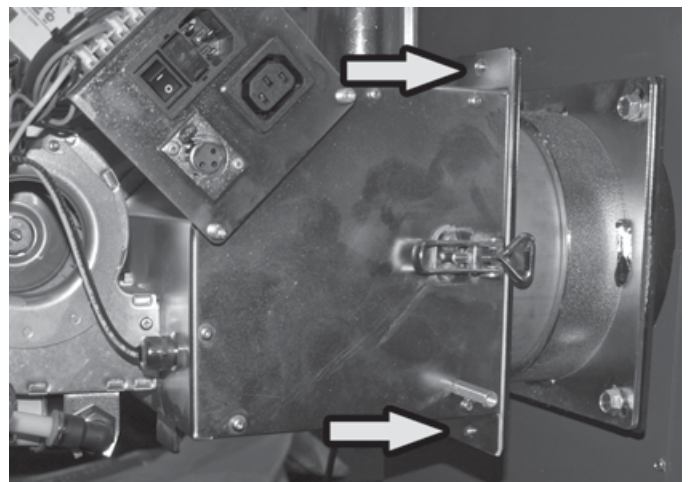

## ***Cleaning of the Turbulators, Tube Box and Ash Box (Weekly or as needed)***

Making sure the boiler is cool and the burner is off, open the top door on the boiler.

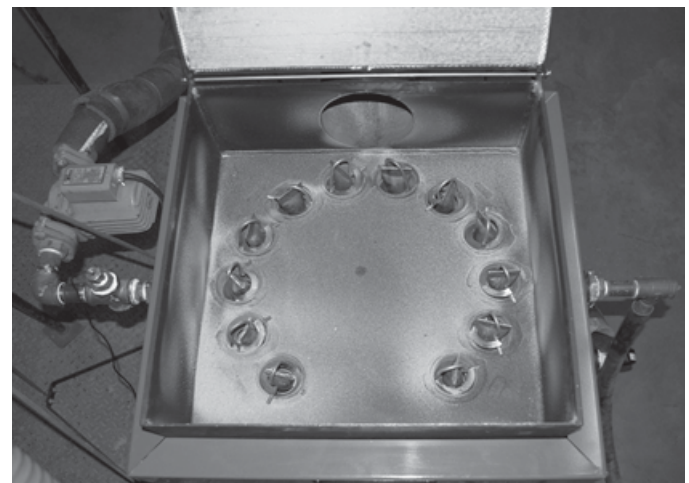

Slide each turbulator up and down to loosen. Insert a J hook into the chuck of a drill and hook the handle of the turbulator into the J hook. With the drill in a medium drive setting that will allow the drill to ratchet, slowly start spinning the turbulator while moving it in an up and down motion. Increase the speed of the drill to allow the turbulator to rattle inside of the tube. Repeat this process for each turbulator.

Once a month each turbulator will need to be removed and cleaned.



Brush out each of the heat transfer tubes once a month when the turbulators are removed for cleaning.

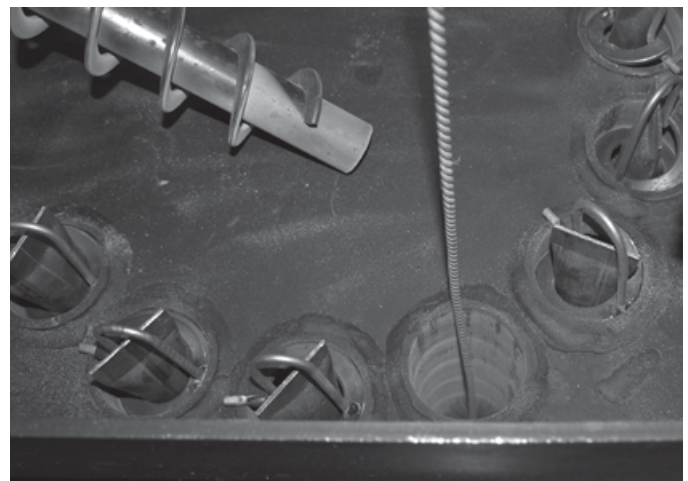



# MAINTENANCE



Vacuum all ash from the tube box, including the door and any remaining ash in the heat transfer tubes.

Make sure the turbulators are in place and close the top door when cleaning is complete.

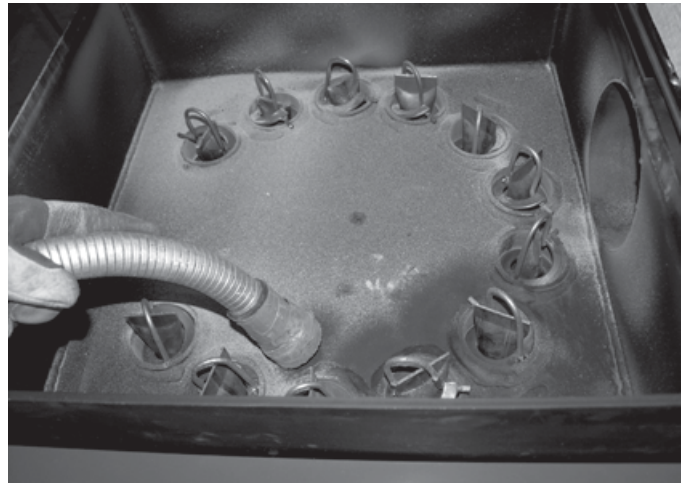

Open the ash box door by unscrewing the two knobs.

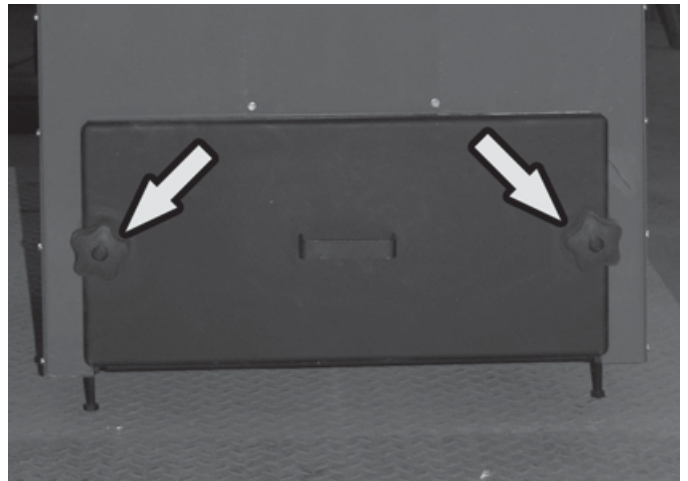

Carefully remove the door and slide out the ash box. Properly dispose of the ash. Clean any ash out of the ash box chamber on the boiler. Replace the ash box and door. Being careful not to damage the ceramic insulation and rope gasket on the door.



**WARNING:** Before performing any of the following tasks, ensure that the power is disconnected from the burner by switching the circuit breaker to the off position, and that all components of the system have had ample time to cool.

### Replacing the Endstop

To replace the endstop, (if installed from the factory) remove the burner from the boiler by following the removal process described on the prior pages.



1. Locate and remove the endstop from the burn pot.

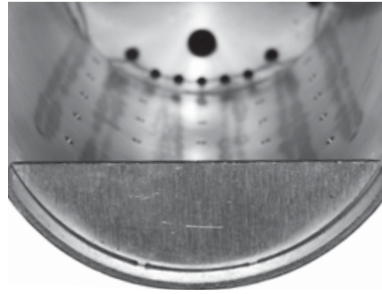

2. Use a pliers or similar tool to press the endstop into the burn pot.

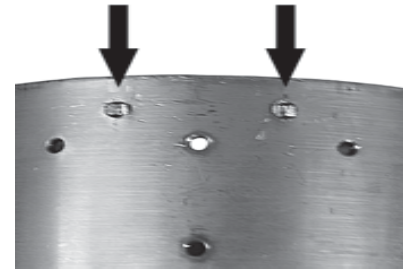

3. Use a screwdriver to lock the endstop into place.

### Replacing the Igniter

The igniter is located inside the air box of the burner. Remove the burner as shown on the prior page. It is recommended to clean the firepot while the burner is removed. Disconnect the two power wires for the igniter. The connection for the wires are located outside of the air box. Then loosen the screw that holds the igniter in the mount. Carefully remove the old igniter and place the new one in the mount. Secure the screw and plug the igniter in. Properly secure all wires. Remount the burner.



### Replacing the Flame Guard

The flame guard is located inside the burn pot of the burner. Remove the burner as shown on the prior page. The flame guard is in the chute of the burn pot. To remove the flame guard, first locate the metal pin that holds the guard in place. Bend one end of the pin straight. Carefully pull the pin out the other end. Carefully put the new guard in place and slide the pin in, ensuring that the pin properly goes through the guard. Once in place, bend the straight end of the pin to lock it in place. Ensure the flame guard moves freely before reinstalling the burn pot in the boiler.

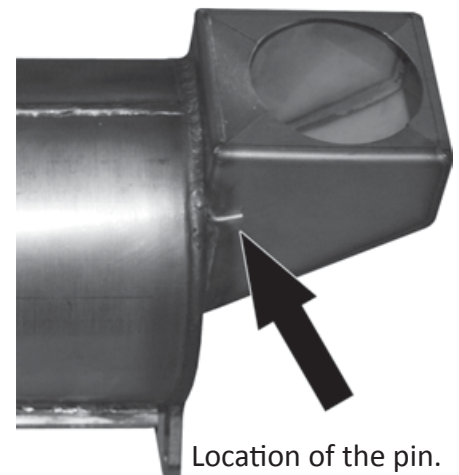

## **Annual Boiler Water Jacket Blow Down**

If antifreeze is being used, water should be drained from the bottom of the boiler and storage tank to remove any sediment buildup. The water should drain until it runs clean, approximately 2 gallons. You can also completely drain and flush your boiler if needed. Remember to recycle your used antifreeze.

**Note:** *Leaving your boiler empty exposes the water jacket to oxygen which will shorten the life of your boiler.*

## **Annual Maintenance:**

Annual maintenance should be performed in the spring when you shut down the boiler for the season.

- Clean all of the ash from the tube access box.
- Clean the heat transfer tubes.
- Clean out the Renovator pellet burner as previously described.
- Clean the ash box and ash box chamber.
- Blow any visible dust off of the motors, pumps, fans, etc.
- Make sure to clean and cover the chimney to prevent water from getting into your boiler when not in use.

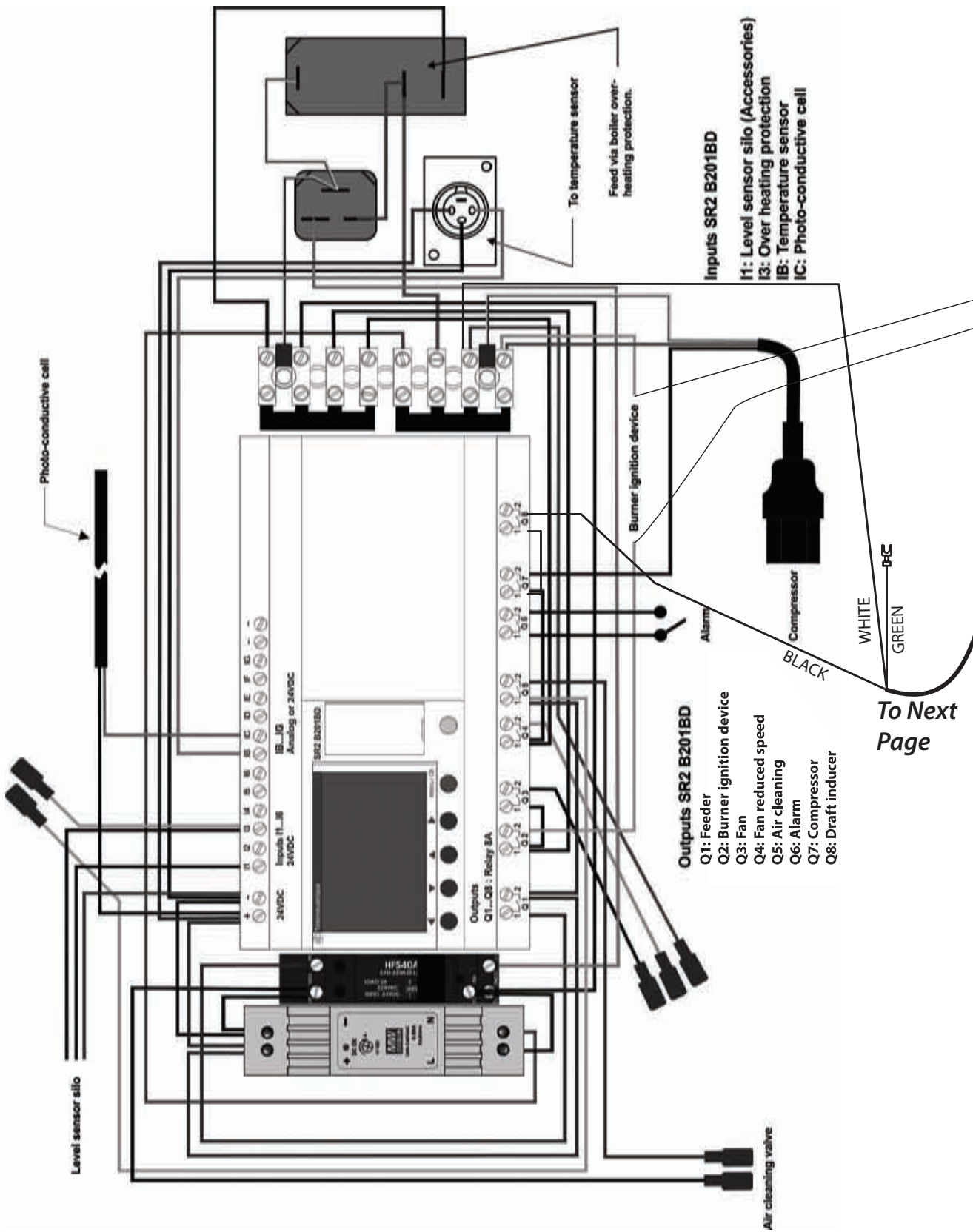

# WIRING

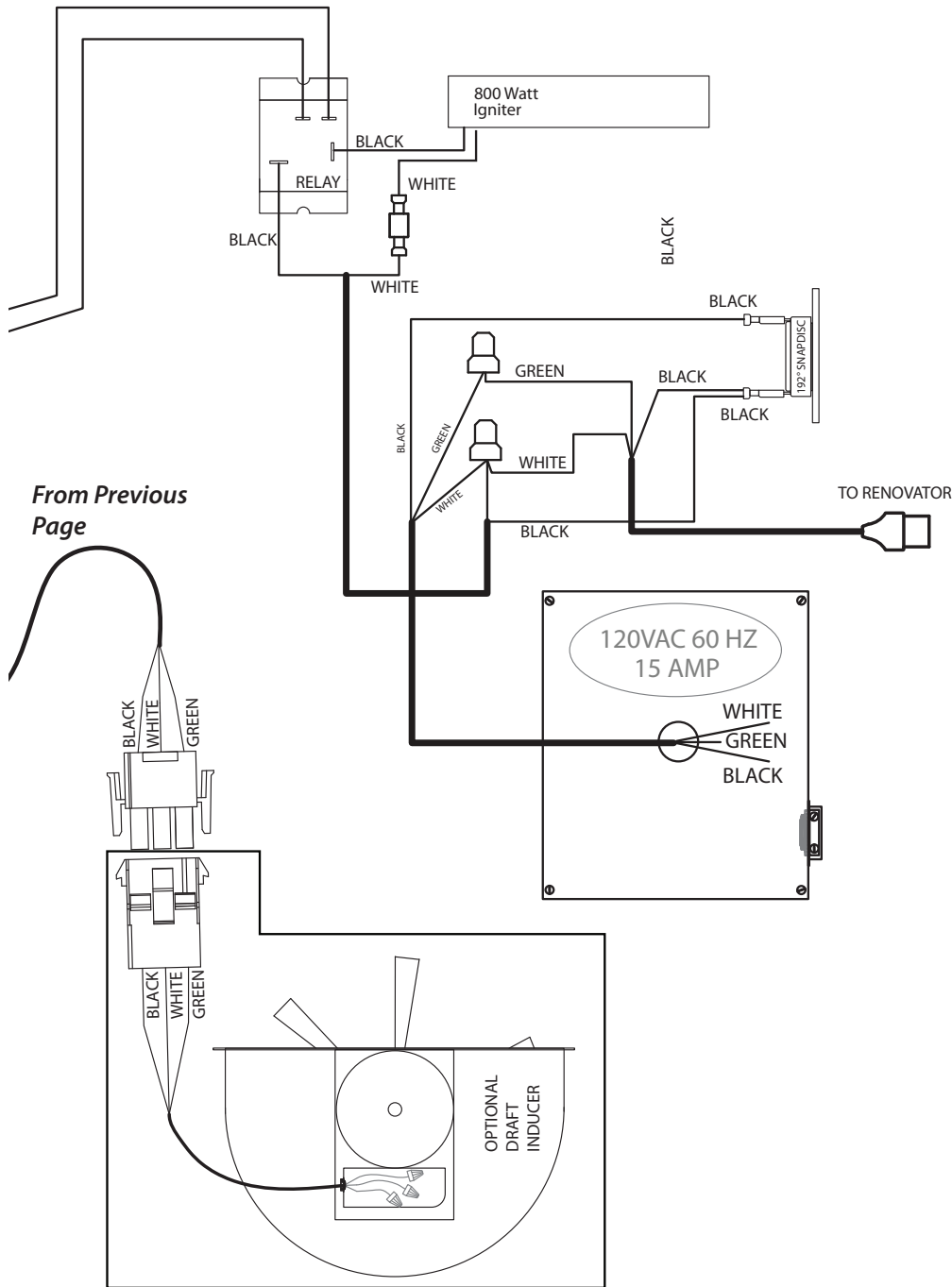

Error	Cause	Solution
The burner has stopped. "Fuel fault" is on the display.	<ol style="list-style-type: none"> <li>1. The pellet hopper is empty.</li> <li>2. An air pocket has developed in the inlet of the feed auger. The fuel is cavatating in the pellet hopper.</li> <li>3. The auger has been blocked by waste.</li> <li>4. The tipping chute is plugged.</li> </ol>	<ol style="list-style-type: none"> <li>1. Fill the pellet hopper with pellets. Restart the boiler.</li> <li>2. Agitate the fuel in the pellet hopper <b>Note: Ensure power to the auger is disconnected before agitating fuel.</b></li> <li>3. Clean the feed auger.</li> <li>4. Decrease the start dose.</li> </ol>
The burner stops even though it ignites.	<ol style="list-style-type: none"> <li>1. Too heavy of feeding during the soft start or combustion phase.</li> <li>2. Flame guard is dirty or broken.</li> </ol>	<ol style="list-style-type: none"> <li>1. Adjust the fuel feed rate.</li> <li>2. Clean or replace the flame guard.</li> </ol>
The burner does not ignite. "Ignition fault" is on the display.	<ol style="list-style-type: none"> <li>1. Incorrect start dose.</li> <li>2. Broken ignition element.</li> <li>3. Stop in tipping chute.</li> </ol>	<ol style="list-style-type: none"> <li>1. Change the start dose.</li> <li>2. Replace the ignition element.</li> <li>3. Clean the tipping chute.</li> </ol>
The burner stops without visible reason.	<ol style="list-style-type: none"> <li>1. Incorrectly adjusted burner.</li> <li>2. Too much back pressure in the chimney.</li> <li>3. Error in the fuel feeding.</li> </ol>	<ol style="list-style-type: none"> <li>1. Adjust the burner.</li> <li>2. Install a draft limiter.</li> <li>3. Test with O2 Sensor</li> <li>4. Clean the feed auger.</li> </ol>
"Overheated" on display.	<ol style="list-style-type: none"> <li>1. Too low of draft in the boiler.</li> <li>2. Safety temp limiter has tripped</li> <li>3. There is no power to the burner</li> </ol>	<ol style="list-style-type: none"> <li>1. Turn off the burner and clean the boiler and burner.</li> <li>2. Check to ensure proper airflow in the System.</li> <li>3. Check to ensure the chimney is not restricted.</li> <li>4. Check the power to the boiler and the burner. Check the breaker.</li> </ol>

# WARRANTY



## **FIVE (5) YEAR LIMITED WARRANTY - PRESSURE VESSEL**

This Warranty is provided by Northwest Manufacturing, Inc. only for the benefit of the initial purchaser (Original Owner) of the Northwest Manufacturing, Inc. WoodMaster Mini Boiler (the "Boiler") on the original site of installation (the "Site of Original Installation"). This Warranty provides specific legal rights. You may have other rights depending on where you live.

The rights in this warranty depend on the proper assembly, installation and commissioning of the Boiler by a dealer or installer who is certified by Northwest Manufacturing, Inc. (the "Certified Contractor"); and proper operation and maintenance. Proper maintenance in accordance with the Maintenance Intervals (as defined herein) must be performed. Installation by an uncertified or unqualified contractor or installer and/or improper maintenance, operation, misuse or abuse of the Boiler shall void this Warranty in whole or in part.

### **LIMITED FIVE (5) YEAR WARRANTY FOR THE PRESSURE VESSEL**

Northwest Manufacturing, Inc. warrants that the Pressure Vessel shall be free of defects in material and workmanship for FIVE (5) YEARS from the Date of Original Installation. If there is a defect in your properly delivered and installed WoodMaster Mini Boiler in the first year, WoodMaster will replace the Pressure Vessel at no cost to the original owner. Northwest Manufacturing, Inc. will only pay costs of warranty work for years two (2) through five (5) – 100% of warranty work, once a defect is determined, repair or replacement of the Pressure Vessel, in a whole or part, will be at the sole discretion of Northwest Manufacturing, Inc..

### **LIMITED ONE (1) YEAR WARRANTY ON THE BURNER AND ELECTRICAL COMPONENTS**

Northwest Manufacturing, Inc. warrants to the Original Owner, That the Renovator Pellet Burner (the "Burner") is free from manufacturing defects for the period of one (1) year from the date of installation. Northwest Manufacturing, Inc. will not warranty the Flame Guard and endstop on the burner, these items are consumable items and in the case of normal wear is the responsibility of the owner to replace as necessary. Northwest Manufacturing, Inc. warrants any electrical components are free from defects for the period of one (1) year from the date of installation. Northwest Manufacturing, Inc. will determine whether to repair or replace the defective parts. This is to include the air compressor and pellet feed auger motor.

### **LIMITED ONE (1) YEAR WARRANTY ON ADDITIONAL COMPONENTS**

Northwest Manufacturing, Inc. warrants to the original owner only, any additional components, including, but not limited to the outer shell, paint, insulation, doors and latches during normal usage for a period of one (1) years from the date of installation.

### **START OF WARRANTY PERIODS**

The Warranty Period shall begin on the date the Boiler and Burner installation has been completed (the "Original Date of Installation"). In the event of dispute as to the Date of Original Installation, the shipping date of your Boiler and Burner, as recorded by Northwest Manufacturing, Inc., shall be deemed to be the Date of Original Installation.

### **WARRANTY LIMITATIONS**

I. Damages for unsatisfactory performance caused by improper installation or any damages caused by or as a result of improper use of the Boiler and Burner, incorrect start-up, incorrect or careless handling, improper control adjustment, incorrect burner adjustment, disregard of the operating instructions and proper maintenance or disregard of any other instructions supplied with the Boiler and Burner, improper operation of the Boiler and Burner or improper alteration and repairs/service by a third party not affiliated with Northwest Manufacturing, Inc. will not be covered under this warranty. All repairs must be performed by a Certified Contractor.

II. The warranty will not cover damage to parts caused by improper installation, improper care or maintenance. The Boiler, Burner and any installed accessories must be serviced, inspected and cleaned at regular intervals. Northwest Manufacturing, Inc. will NOT warranty damage to the Boiler and Burner due to ash corrosion.

III. The workmanship, repairs or replacement of parts of the Certified Contractor will not be covered under this warranty.

IV. Components of the heating system not furnished by Northwest Manufacturing, Inc. as part of the Boiler and Burner and components of the Burner are not covered under this Warranty. Damages caused by components of the heating system not supplied by Northwest Manufacturing, Inc. will not be covered under this Warranty.

V. Fuels used in the Burner must meet the specifications set out by Northwest Manufacturing, Inc.. Suitable fuels are listed in the owners manual. Damage caused by the use of any unapproved fuel, or any fuel that does not meet the guidelines set forth by Northwest Manufacturing, Inc. will not be covered by this warranty. The burner must be tested and tuned to proper feed rates according to the owners manual. Failure to properly tune the burner will result in a voided warranty.



# WARRANTY

VI. Any costs for labor for the examination, removal or reinstallation of allegedly defective parts, transportation of the parts to and from Northwest Manufacturing, Inc. facilities will not be covered and will be the responsibility of the Original Owner. This includes any other labor and costs for any material necessary for the said examination, removal or re-installation.

VII. The warranty will not cover damage to the Boiler and Burner or any of their original parts, replacement parts or other accessories or standard equipment caused by excessive temperatures or pressures, vandalism, fuel or gas explosion, electrical, chemical or electrochemical reaction, electrical failures, insurrection, riots, war, acts of God, combustion air contaminated externally, air impurities, sulfur or sulfuric action or reaction, dust particles, corrosive vapors, oxygen corrosion, and situating the Boiler and Burner in an unsuitable location or continuing use of the Boiler and Burner after onset of a malfunction or discovery of a defect.

VII. Consumable parts, and parts in direct contact with the flame, will not be covered under this warranty.

## WARRANTY TERMS

The Warranty shall also be subject to the following terms and conditions:

I. The Boiler and Burner must have been installed by a Certified Contractor.

II. The Boiler and Burner must have been properly maintained, cleaned and serviced during the Warranty Periods in accordance to the manual.

III. This Warranty is non transferable and only covers the Original Owner, at the original site of installation.

IV. Northwest Manufacturing, Inc. shall have the time needed and unobstructed access to the Boiler and Burner for the purpose of conducting tests of the Boiler and Burner and for the making of repairs or installation of replacement parts.

V. Repairs, replacement or the repair of replacement parts shall be subject to the terms and conditions of this Warranty as if they had been installed at the time of original installation.

VI. This Warranty is limited to the provisions previously described and does not extend to any Boiler and Burner, related parts or products that are (a) not sold in Canada or the United States; (b) not installed in Canada or the United States; or (c) not purchased from an Authorized Distributor.

VII. Northwest Manufacturing, Inc. shall not be responsible for any consequential damages, direct or indirect caused by the products described in this Warranty.

## APPLICABLE LAW

All disputes or claims on the Warranty shall be determined in accordance with the laws of Red Lake County, Minnesota.

## WARRANTY CLAIM/SERVICE

Notify the Certified Contractor who installed your Boiler and Burner. The Contractor will then notify Northwest Manufacturing, Inc. who will make all warranty decisions. No warranty work can be carried out without approval from Northwest Manufacturing, Inc.. If the Certified Contractor fails to make a warranty claim, contact Northwest Manufacturing, Inc. directly. Allegedly defective parts MUST be returned to Northwest Manufacturing, Inc. for the purpose of inspection to determine cause of failure.

Northwest Manufacturing, Inc. / 600 Polk Ave. SW / Red Lake Falls, MN 56750-5002  
(800) 932-3629 • Fax: (218) 253-4409 / [www.woodmaster.com](http://www.woodmaster.com)





Cut here and mail registration card

Northwest Manufacturing Inc.  
600 Polk Ave. SW  
Red Lake Falls, MN 56750

PLACE  
POSTAGE  
HERE

Northwest Manufacturing Inc.  
600 Polk Ave. SW  
Red Lake Falls, MN 56750

# WoodMaster Mini Boiler Warranty Registration Card

Please fill out the warranty registration card below and mail it back to us.

Failure to register may delay warranty claims.



Serial Numbers	
Burner	_____
Vessel	_____

Owners Name \_\_\_\_\_

Address \_\_\_\_\_

City \_\_\_\_\_ State \_\_\_\_\_ Zip \_\_\_\_\_

Daytime Phone \_\_\_\_\_ Home Phone \_\_\_\_\_

Email \_\_\_\_\_ Date of Purchase \_\_\_\_\_

Dealers Name \_\_\_\_\_

Address \_\_\_\_\_

City \_\_\_\_\_ State \_\_\_\_\_ Zip \_\_\_\_\_

Phone \_\_\_\_\_

How did you learn about our product?

Radio  Newspaper  Internet  TV  Print  Other \_\_\_\_\_

Would you like information on other products from Northwest Manufacturing, Inc.?  Yes  No

Measured start dose in grams: \_\_\_\_\_ Dosage time in seconds: \_\_\_\_\_

Setting of operation time, On \_\_\_\_\_ Off \_\_\_\_\_ Max run time: \_\_\_\_\_

Flue Gas Meter Readings: O2 % \_\_\_\_\_ CO2 % \_\_\_\_\_ PPM CO \_\_\_\_\_ Stack Temp \_\_\_\_\_ Draft \_\_\_\_\_  
(Degrees Farenheit) (In H2O)

I have read the owners manual and understand the proper usage of my WoodMaster Mini Boiler.

Signature \_\_\_\_\_ Printed Name \_\_\_\_\_

Cut here and mail registration card



# SPECIFICATIONS



Power Connection	Single Phase, 120v, 60 Hz
Maximum Current Draw	9.31 Amps @ 120 v, 60 Hz
800 Watt Igniter (Max Draw)	6.67 Amps @ 120 v, 60 Hz
PLC (Max Draw)	0.3 Amps @ 120 v, 60 Hz
Auger Motor (Max Draw)	1 Amp @ 120 v, 60 Hz
Combustion Fan (Max Draw)	0.34 Amps @ 120 v, 60 Hz
Optional Draft Fan (Max Draw)	1 Amp @ 120 v, 60 Hz
Maximum Power - Input (30 kW unit)	102,000 BTU
Weight	785 Pounds (approx.)
Boiler Height	38" (approx.)
Boiler Width	26.5" (approx.)
Boiler Depth	33.5" (approx.)
Poly Hopper Height	56" (approx.)
Poly Hopper Width	28" (approx.)
Poly Hopper Depth	40" (approx.)
Metal Hopper Height	52" (approx.)
Metal Hopper Width	24" (approx.)
Metal Hopper Depth	24" (approx.)
Hopper Capacity	280 Pounds (approx.)
Water Jacket Capacity	9.5 Gallons (approx.)
Ash Box Volume	1.74 Cubic Feet (approx.)
Normal Working Pressure	12-20 PSI
Maximum Working Pressure	30 PSI



[www.woodmaster.com](http://www.woodmaster.com) / 800-932-3629 / Manual PN: 7994-890

Northwest Manufacturing, Inc / 600 Polk Ave SW / Red Lake Falls, MN 56750