



A-250, A-350, & A-450 Warm Air Furnace

Operating instructions and maintenance enclosed
Thoroughly read and understand instructions
Always leave this manual with stove owner

Follow the instructions within this manual. If instructions are not followed, a fire may result causing property damage, personal injury, or even death.

A carbon monoxide detector has been supplied with your stove. You must plug it in.

Danger risk of fire or explosion. Do not burn garbage, gasoline, drain oil, or other flammable liquids. Do not use chemicals or fluids to start fire.

Burn rice or buckwheat anthracite coal only

Stoves surfaces may be hot while in operation. Keep children away. Do not touch during operation

Do not connect this unit to a chimney flue serving another appliance.

Follow all local building and Zoning ordinances

INSTALLATION INSTRUCTIONS FOR A-250, A-350, & A-450

1. Place furnace floor (located in carton marked top A-450 are shipped separate) on a flat level surface. The end of floor without angle is stoker-hopper end.
2. Floor without opening is the stack end and should be placed in the direction of the chimney.
3. Stand furnace on furnace floor and center it from side to side. Front of furnace must be even with edge of furnace floor. Ash door frame will extend beyond end of the floor.
4. Install flat rope gasket around furnace exhaust flange (gasket is supplied in ash tub).
5. Connect heat exchanger to furnace. Make sure that the stack and cleanout outlets are in their lowest position. Tighten nuts securely in an alternative diametric patten to slightly compress the rope seal between flanges.
6. Install (4) heat exchanger legs (rear legs are cut on an angle) (**A-250 only has 2 rear legs**). After connecting heat exchanger and furnace with bolts, front legs **MUST** be removed from heat exchanger.
7. Place front blank side panel of jacket in floor slot and in the slot on the front face plate of furnace.
8. Install rear blank side panel of jacket into floor slot and screw fast using screws found in jacket top box.
9. Find bottom partition in top box (silver piece with square hole in it, found in top bow) pry open S cleat bend on the top end of partition. Slide bottom partition (silver piece with square hole in it behind angle on rear panel of the jacket piece just installed But do not secure with screws until step 11.
10. Install door front panel of jacket using same procedure as opposite side panel.
11. Install door rear panel using same procedure as rear blank panel and secure using same type of screws found in top box .

INSTALLATION INSTRUCTIONS FOR A-250, A-350, & A-450

12. Place stack bib over stack and clean out ports and fasten with screws.
13. Install blank plate over unused fire door hole in the jacket.
14. Crawl under heat exchanger and slide bottom partition against angles on inside of jacket. Drill 1/8" holes and secure with screws.
15. Take hopper support bar off of bolts on front of furnace and set aside.
16. Install front hopper bib, **by sliding angle on bottom of bib, into slot on furnace plate.**
17. Then drill four 1/8" holes through predrilled holes in hopper bib sheet and secure with sheet metal screws provided in jacket top box.
18. Find top partition (silver piece in the top box with a half circle cut out). Reach over top of jacket, place top partition into S cleat bend on the top of bottom partition. Don't secure now.
19. Place jacket top over jacket side panels being sure filter rack is over heat exchanger, and secure with screws. (A-450,000 jacket top has two sections). Install screws through top partition into angle protruding down off of jacket top.
20. Plenums may now be installed.
21. Install handles on blower door. Insert handle through hole in blower door. Drive perforated locking washer tight up against fan door, place latch on handle and tighten screw in latch.
22. It may be necessary to adjust stack bib up or down to allow fan door to close and seal properly.

Center fire door, in opening provided, and drill 1/8" holes (1 in top of door frame and 1 in bottom of door frame). Put a light smear of furnace cement or high temperature silicone around fire door opening before installing fire door. Furnace cement or high temp silicone not included. Then fasten door with two self-drilling screws, provided in ash tub. Install spring handle on fire door. Bend hook open on

INSTALLATION INSTRUCTIONS FOR A-250, A-350, & A-450

spring handle and thread it through predrilled hole in fire door handle. Then re-bend spring handle closed. Also found in ash tub.

Fasten jacket panels to floor slot and top slot, by drilling 1/8" holes and securing with sheet metal screws. (Install screws whenever necessary to insure quiet operation during convection blower cycles).

Install hanging baffles: reach in through stoker unit opening, and hang small baffle (**found in the furnace A-450 does not have a small baffle**) over opening entering into heat exchanger. Then by reaching in through stoker unit opening, hang large baffle on angles that are welded inside furnace.

Before installing stack pipe, slide rings with screws over stack outlets, and slide against rear bib. Tighten screws.

Place galvanized cap over exhaust port that is not going to be used for chimney connection.

Assemble blower- Fasten left and right legs to blower housing. Place rubber grommets in holes of legs. Place the slotted motor mount bracket on blower housing and secure with screws. Slide two square head bolts into channel of motor mount. Place bracket of fan motor over square head bolts and loosely place nuts and bolts. Install large pulley on blower shaft, and small pulley on motor shaft. Mount belt adjustment angle on fan motor bracket. Place belt over both pulleys. Align pulleys. Then tighten pulleys motor mounts (See instructions found with blower). Slide blower into blower cavity. **CAUTION: DO NOT PUSH BLOWER BEYOND CENTER PARTITION.**

IMPORTANT: Blower belt must be somewhat loose. Making belt too tight will cause excessive and rapid wear on sleeve bearing in both blower and motor. Blower is freestanding and does not need to be bolted to furnace floor.

Slide filter(s) into filter bracket on return end of furnace.

Slide ash door down over hinge pins.

Install a light smear of furnace cement or high temperature silicone. Remove and dispose of shipping screw from gear box. Stoker units are shipped completely assembled. Lift stoker into opening, stoker bottom has 1/4" rod welded in place

INSTALLATION INSTRUCTIONS FOR A-250, A-350, & A-450

which must go inside stoker opening. Place a thick smear of furnace cement on flange of stoker and tilt into place. Secure with 3/8 x 1 1/4" machine screws, washers, and nuts.

Place hopper on stoker unit. Place hopper support bar in hopper on bolts and fasten hopper and support bar (**A-250s do not have support bar**) to furnace with large sheet metal washers and nuts. Hopper bottom should lap over stoker throat approximately 1". Since same hopper is used with different stokers, it may be necessary to trim opening of bottom of hopper. Bend flange down to fit inside of throat of stoker to be sure feed mechanism is free to operate.

Mount Timer and Relay harness on Furnace Jacket (see diagram on pg7). Cut 7/8" opening in supply plenum chamber to install Fan Limit control and secure with screws.

Connect 115 volt power supply to switch, black wire gets connected to open screw on switch, white wire gets wire to single white wire in switch box. Wire furnace following wiring diagram and any applicable UL, or local codes. Furnace must be on its own 20 amp circuit.

Locate thermostat in an area where heat from furnace can free be reached. Mount plastic wall plate of thermostat. Connect thermostat wires to screws on lower portion of wall plate. Run thermostat wires to relay on furnace and connect wires to terminals marked T.T. (note color coding is unimportant).

After making electrical connections, turn blower on. Be sure blower is running proper direction. To change blower direction, follow blower instructions on blower motor or install motor on opposite side of blower Wire stoker unit and convection blower also

After making electrical connections, turn blower on. Be sure blower is running in proper direction. Mount motor on left or right side of blower will cause blower to run CW or CCW. To change direction, follow instructions on motor. (See diagram on motor plate for changing direction)

INSTALLING STACK PIPE: Heat exchanger has two stack outlets. Either one may be used to connect stove pipe to chimney. The other opening must be capped and is to be used for a clean out during maintenance. We recommended that you use the outlet closest to chimney for stack. It is important to run full size stack from furnace to thimble in chimney. If stack pipe must be reduced it needs to be

INSTALLATION INSTRUCTIONS FOR A-250, A-350, & A-450

reduced at chimney thimble. Install barometric draft control in first full section of stack closest to furnace. Follow instructions packed with draft control, making sure draft control bearings are level and face of control is perpendicular to floor.

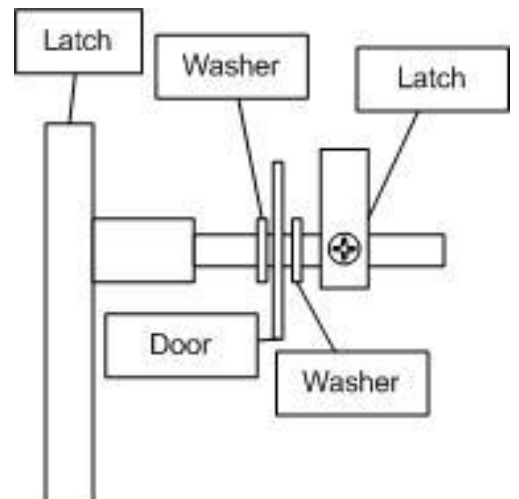
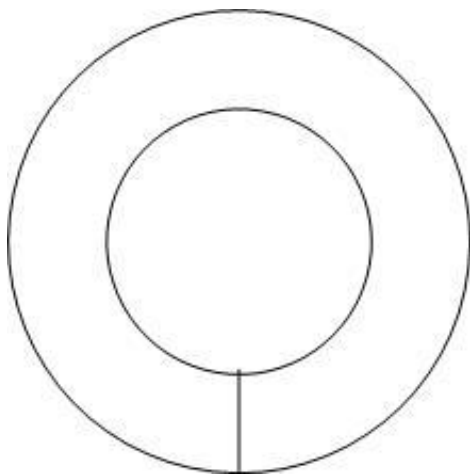
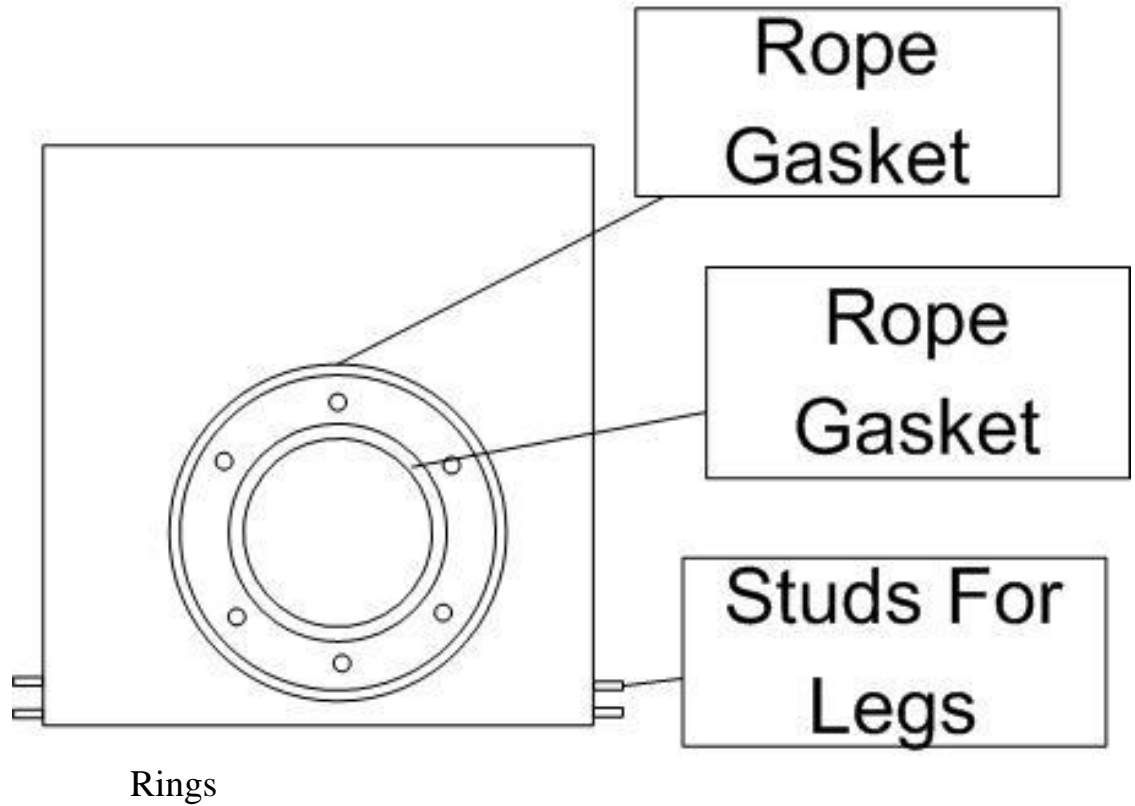

INSTALLATION INSTRUCTIONS FOR A-250, A-350, & A-450

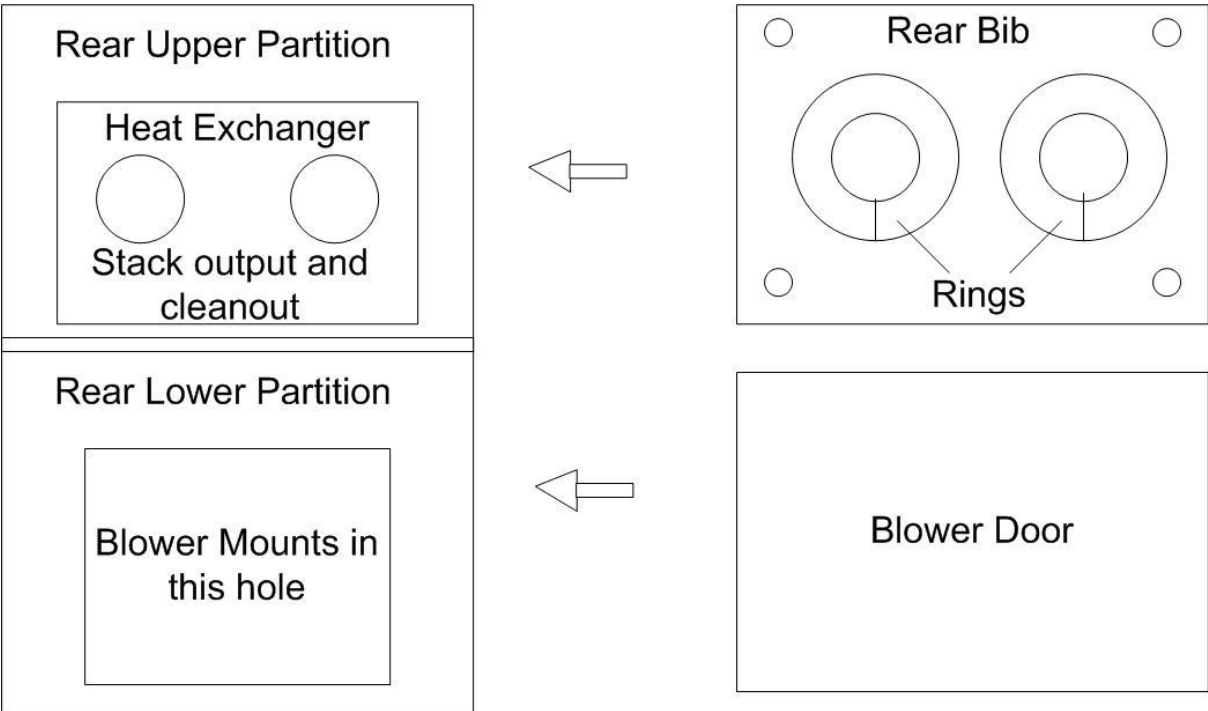
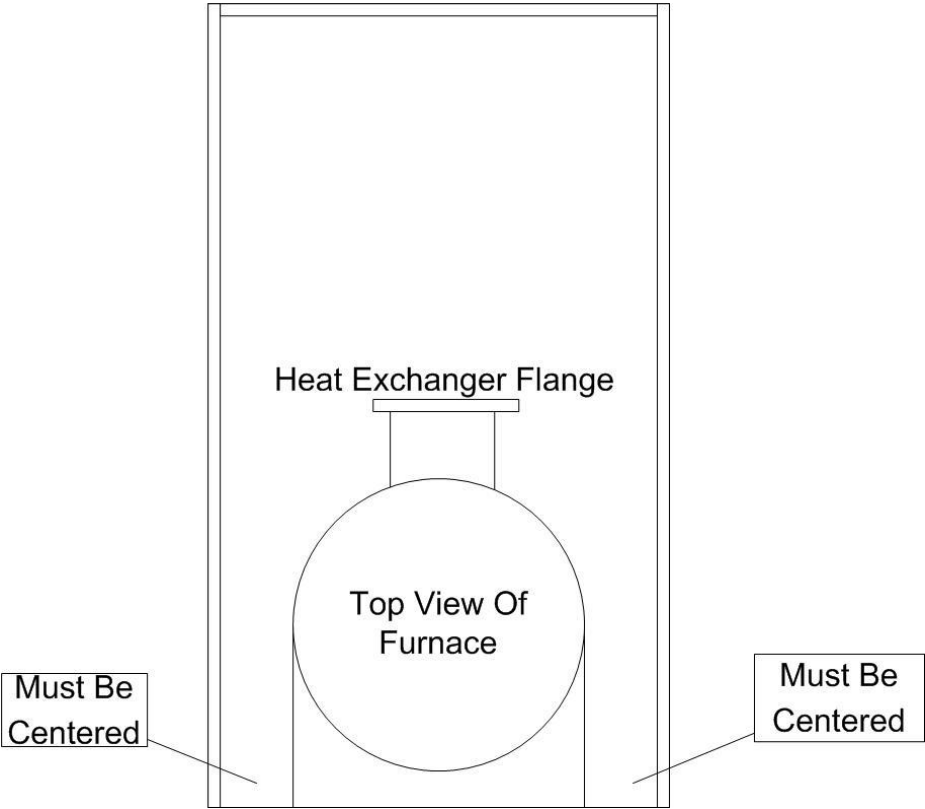

INSTALLATION INSTRUCTIONS FOR A-250, A-350, & A-450

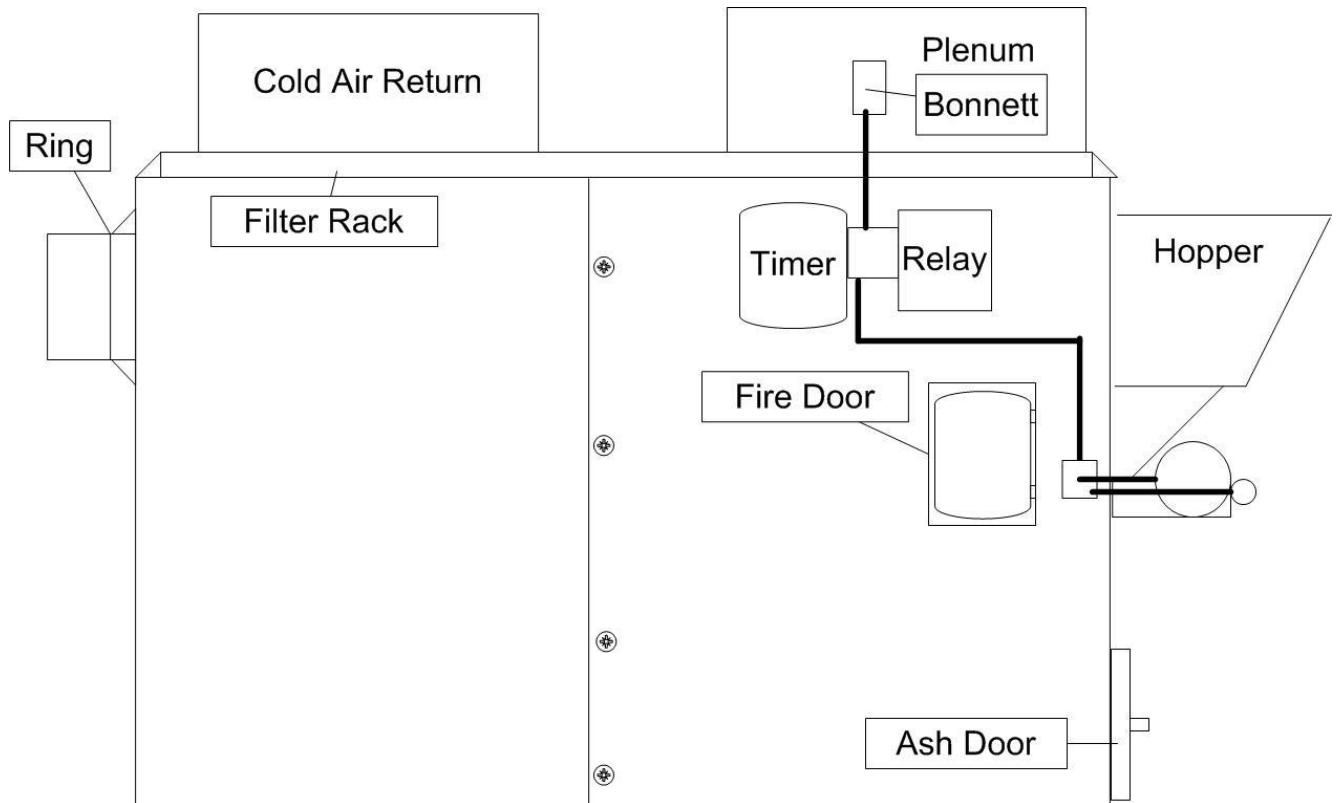
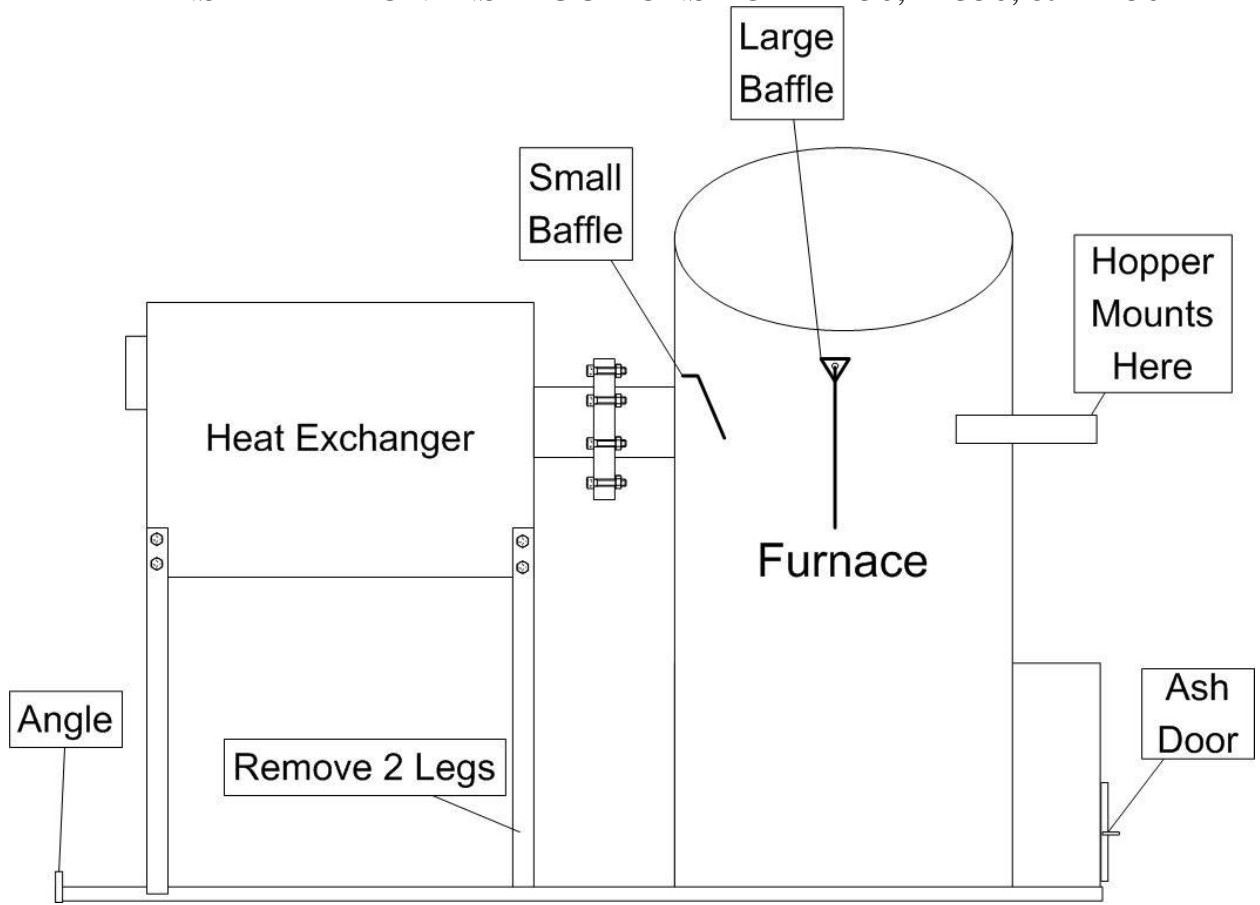

INSTALLATION INSTRUCTIONS FOR A-250, A-350, & A-450

1. Stoker Body
2. Side Rail Left K-2C
3. Side Rail Right K-1C
4. Grate K-15-1-L
5. Grate K-15-2-L
6. Grate K-15-3-L
7. Grate K-15-4-L
8. Motor
9. Blower Rotor
10. Bearing K-19
11. Throat Strap K-18
12. Pusher Bar Drive Yolk K-8-BC
13. Pusher Bar K-9-BC
14. Pusher bar drive shaft
15. Bearing K-17
16. Feed Crank K-7
17. Feed Assembly Connector
18. Feed Arm Nut
19. Feed Arm Adjustment Nut
20. Feed Latch K-12
21. Feed Spring
22. Feed Bolt
23. Drive Wheel K-5
24. Gearbox K-14
25. Coupling

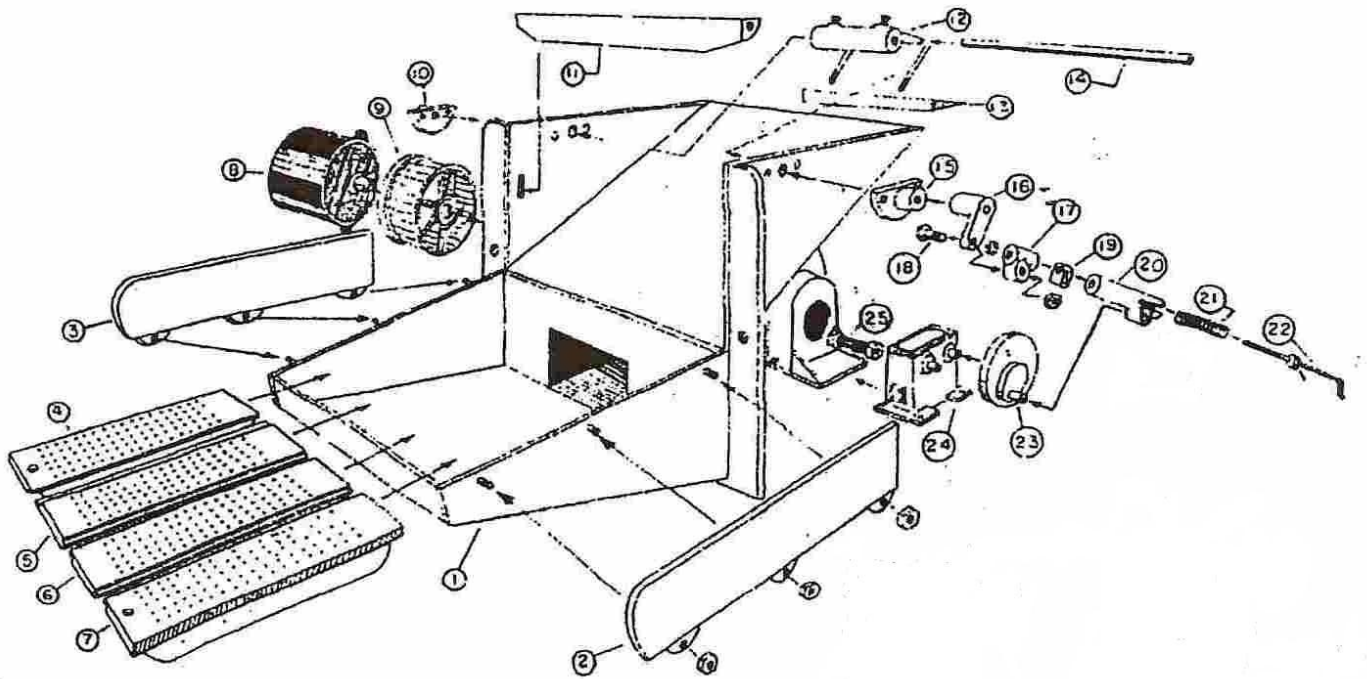

INSTALLATION INSTRUCTIONS FOR A-250, A-350, & A-450

STARTING FIRE: **NOTE DO NOT USE AN ACCELARANT SUCH AS; gasoline, kerosene or litter fluid.** Put dry coal in hopper, pull coal to cover entire grate. Crush several charcoal briquettes into smaller pieces on one sheet of newspaper. Crumble newspaper and dig it through the coal, so it touches the grate. Light charcoal with a match, turn on switch, when charcoal turns red and sparks, place a few hands full of coal on top of charcoal.

If fire moves toward bottom of grate before fire is established, coal feed can be slowed down turning red nut CCW or by flipping feed bolt to a sideward position (Part #22 on unit specification sheet)

After a fire has been established and all fresh coal laying on grate has burned, its time to set coal feed. When stoker unit is running steady (approximately 1 hour) fire bed should extend downward to lower portion of grate with approximately 2" of ash on bottom of grate . When thermostat is satisfied, stoker unit will shut off. When stoker only runs during timing cycle, the fire bed will gradually shrink to approximately 3" to 4" of red coals. After proper length of fire bed is obtained, coal feed is set.

AFTER STARTING COAL FIRE: Allow stove and chimney to warm up. Insert draft gauge through pre-drilled hole in upper portion of fire door. Open air shutter (located on bottom of scroll between stoker motor and gear box about 1/2"). Then with stoker motor running and feeding coal adjust the barometric damper until draft gauge reads (-.02). If draft is less than a (-.02) draft with the barometric damper closed you must close the air shutter (between gear box & stoker motor) a little and recheck. Repeat until you obtain a (-.02) draft.

If the draft is higher than (-.02) you must adjust the barometric draft regulator. Move the weight on barometric regulator left or right to obtain the (-.02) Recheck the draft until you obtain a (-.02).

SETTING TIMER: Timer is factory set. Yellow clock wheel makes one revolution every thirty minutes. Each clip sticking out of yellow wheel will cause stoker to run approximately 15 seconds when clip touches switch. Timer settings will vary depending upon chimney drafts. Normal timing cycle is about one minute on, 14 minutes off. (4 clips side by side) four clips at 0 and 4 clips at 15. If timing cycle needs to be increased, add 1 or 2 clips to both

INSTALLATION INSTRUCTIONS FOR A-250, A-350, & A-450

groups of clips. Or if in case of chimney having poor draft, clips may be placed in 3 groups at numbers 0 – 10 -20.

Coal Feed (Red Nut) To Increase Coal feed and fire size, turn red nut CW
To Increase Coal feed and fire size, turn red nut CCW

After a fire has been established and all fresh coal that was laying on grate has burned, its time to set coal feed. A starting point for coal feed for rice coal turn red nut coal (feed adjustment) all the way forward and then 10 turns back. For buckwheat coal turn red nut (coal feed adjustment) all the forward When stoker is running steady (approximately ½ hour) fire bed should be extended downward to lower portion of the grate with approximately 2” of ash on bottom of grate. When thermostat is satisfied, stoker unit will shut off.

When stoker only runs during timing cycle, the fire bed will gradually shrink to approximately 3” to 4” or red coals. After proper length of fire bed is obtained, coal feed is set.

During winter operation, hot coals should never be pushed off end of grate. This indicated that coal feed needs to be reduced (CCW) or if during winter operation; fire bed is too small, turn red nut (CW).

After coal feed adjustment is completed, if during summer, the water is too hot.... **DO NOT ADJUST COAL FEED.** Reduce timer only. If fire goes out **DO NOT ADJUST COAL FEED.** Increase timer only.

CLEANING AND SERVICING: It is most important to clean and lubricate furnace when shutting it down at the end of heating season. Corrosion of heating equipment is greatly reduced by not allowing soot to remain in furnace during summer months.

Remove and clean stack pipe, clean base of chimney. Examine chimney for blockage with a mirror. Brush off barometric damper. Clean tubes and area around tubes in heat exchanger, including entrance into chamber of furnace.

Remove clean out plate (See unit specifications) from stoker unit by removing 2 screws and vacuuming out fly ash from under grate annually.

INSTALLATION INSTRUCTIONS FOR A-250, A-350, & A-450

Oil stoker motor and blower motors with SAE 20 non detergent motor oil. Oil gear box with #90 Gear Oil – Oil level should be not less than ½ full, and no more than ¾ full.

Remove all coal from hopper, -remove hopper – place a few drops of oil on all moving parts, joints, and bearings to prevent freeze up.

Replace Air Filters

Using a chisel or brick – scrape grates smooth. Then rub grates and inside of side rails with sand paper to remove impurities that melted and fastened themselves to grate.

As prices of fuel continue to increase **KEYSTOKER**, continues to improve and make its products more fuel efficient. To obtain a more complete burn out coal, a small secondary blower motor was attached to the stoker unit. **THIS MOTOR IS DESIGNED FOR CONTINOUS RUN.**

When large stoker motor is running on demand, small blower will assist with combustion and heat output, by producing a more intense and hotter fire. When demand cycle is completed, large stoker motor will shut off, and small secondary motor will continue to run. This will cause the coal that is already on the grate to burn, rather than to allow coal to smolder and die out in an unburned condition. This will achieve a cleaner ash, and allow more heat to be produced and absorbed into heating system.

During summer operation, the small combustion motor will force a small amount of air through grates at all times, which will cause the ash to become like powder. It also prevents the fire from going out. At the same time, it reduces the size of fire bed to approximately 1 ½” to 2” which will prevent boiler water from becoming overheated.

INSTALLATION INSTRUCTIONS FOR A-250, A-350, & A-450

CONTROLS AND THEIR FUNCTIONS

THERMOSTAT: Top pointer is desired room temperature. Bottom pointer is thermostat. When room temperature drops below setting, combustion blower and gear motor will start. When room temperature rises, gear motor will stop (see diagram pg. 10).

RELAY: Converts 115v to 24v for thermostat, and sends signal to gear motor to start or stop.

CONVECTION BLOWER: Located behind enclosure on the left of stove. Blows heated air into the room. It is energized by the fan and limit control.

FAN & LIMIT CONTROL: Serves dual purpose. 1. As a high limit, will shut off the stoker unit to prevent overheating. If internal stove temperature reaches 200 degrees, control will shut off stoker unit, until temperature drops, which will then allow stoker unit to be reactivated. 2. As a convection blower control, it starts the convection blower when internal stove temperature reaches center pointer setting. The convection blower will run as long as stove remains hot. When stove begins to cool down to low setting on control, the convection blower will shut off. Normal settings for control are: High limit (pointer on right) 200 degrees. Center pointer (fan on) 160 degrees. Left pointer (fan off) 120 degrees. White button in control must be pulled out for normal automatic operation .

STOKER MOTOR: Function is to drive feed mechanism (pusher bar) to slide coal from hopper onto the grate, to move the fire forward and the ash into the receptacle.

SECONDARY BLOWER: To run continuously and assist with combustion when there is a demand for heat. Helps keep furnace from over- heating and keeping fire lit when in idle mode.

TIMER: Will activate gear motor on stoker unit, to maintain a fire during periods when no demand is made by thermostat.

INSTALLATION INSTRUCTIONS FOR A-250, A-350, & A-450

THERMOSTAT

Top pointer is to be set at warmth desired in home. Bottom pointer is the present temperature in room. When room temperature (bottom pointer) below desired room temperature, (top pointer), this will send a signal to the Relay control to activate gear motor to push fresh coal onto grate

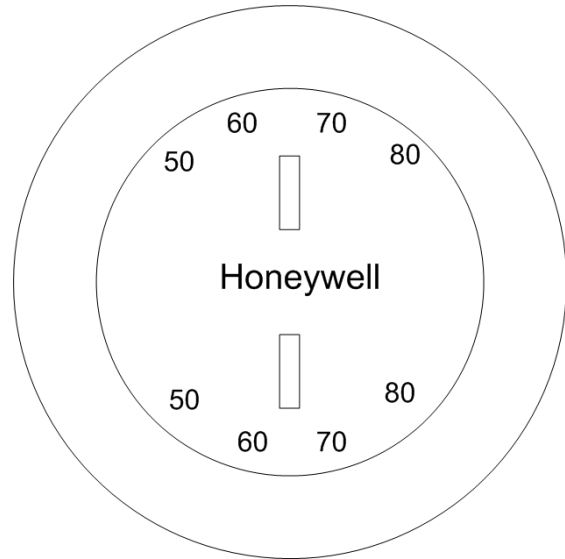

FAN LIMIT SWITCH

1. **HIGH LIMIT POINTER**-is a safety switch that stops gear motor from pushing coal onto grate at 200 degrees (If stove gets too hot, this switch will turn off gear motor).
2. **CENTER POINTER**-turns convection blower on when internal air temperature reaches this setting (normally set around 160 degrees, but is adjustable).
3. **LOW POINTER**-turns convection blower off when internal air temperature falls to this setting (normally set around 120 degrees, but is adjustable).
4. Whatever number on silver dial is directly above this point is temperature of internal air.
5. **WHITE BUTTON**-pull out for automatic operation of convection blower. Push in for constant running of convection blower.

INSTALLATION INSTRUCTIONS FOR A-250, A-350, & A-450

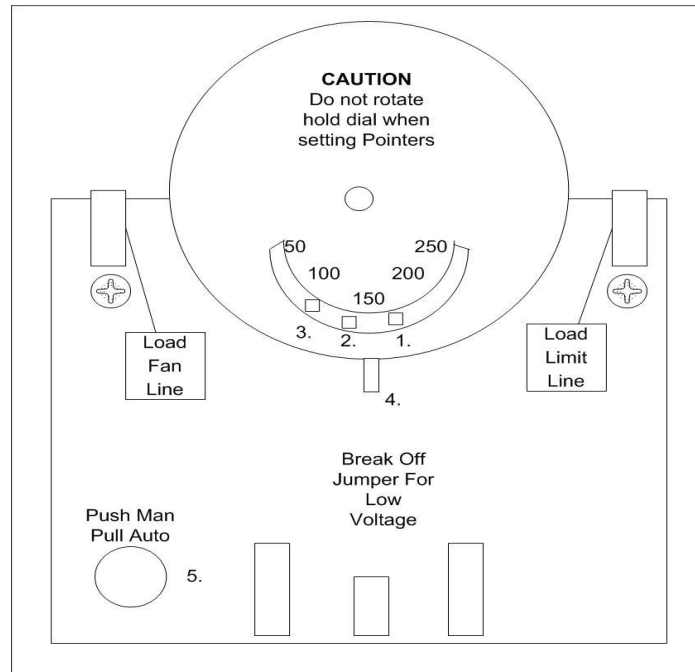

CONVECTION BLOWER-when running, it will take cool air from room, and force it through heated air chamber inside stove, and return heated air into room. Blower can only be activated by Fan Limit Switch.

TIMER The purpose of a timer is to **maintain a minimum** fire when thermostat is not calling for heat.

The timer is factory set to run 1 ½ minutes every 10 minutes. The timer activates the gear motor, which will cause the pusher bar to move in a reciprocating motion, forcing coal onto grate.

The timer has a large yellow wheel that makes 1 revolution every 30 minutes. Pins can be inserted or removed from yellow wheel. Each pin equals about 15 seconds, if needed, extra pins can be added to the present groups of pins or pins can be inserted anywhere in yellow wheel.

This section **ONLY** pertains to periods when thermostat is not calling for heat. If the fire goes out, you will have to add more pins to timer **OR** increase coal feed.

INSTALLATION INSTRUCTIONS FOR A-250, A-350, & A-450

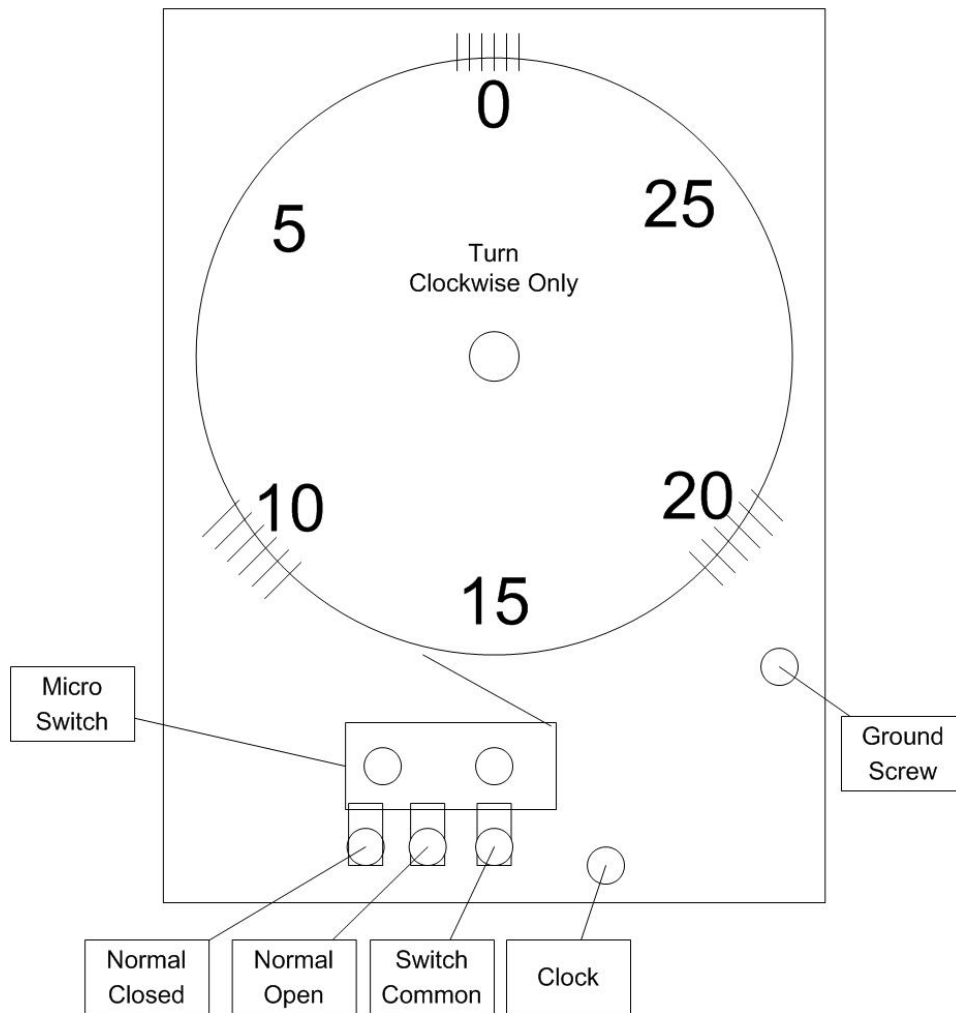

The burning coals should be the width of the grate and about 1 ½” to 2” in length. If the burning coals get any less than 1 ½” the fire may go out.
SOLUTION: Increase coal feed.

A weak draft can also cause the fire to go out, if fire appears to be very dull, add as many extra pins to timer as needed, until fire stays lit.

If convection blower cycles on and off often and produces too much heat, whether the fire bed is too long or timer is running too long. If you reduce coal feed or remove timer pins, do not make radical changes. Reduce coal feed 1 or 2 turns OR remove 1 pin from timer. Then wait several hours before making any more reductions. A sudden radical change may be too much and cause fire to go out.

Once the coal feed and timer are set and fire stays lit, without convection blower running too much, it is usually not necessary to make any more changes.

SAFETY

THE BURNING OF FOSSIL FUELS GENERATES CARBON MONOXIDE GASES. CARBON MONOXIDE GASES ARE TOXIC, CAN CAUSE SICKNESS, AND CAN BE FATAL.

To prevent toxic carbon monoxide gases from entering the home, certain precautions must be taken.

The ash tub **must be** emptied on a regular basis to prevent ashes from overflowing into ash pit area. Excessive ash accumulation may impede air flow to the chimney, preventing gases to be drawn up chimney.

Fire and Ash doors must be closed at all times during normal operation.

It is necessary to keep some coal in hopper while stove is in operation.

In most applications it is sufficient to clean stove and stove pipe twice during the heating season. However, under extreme weather conditions or by high demand on stove running periods, the stove and stove pipe may need more frequent cleaning. Clean as often as necessary.

CAUTION ASH PAN IS HOT! ALWAYS WEAR GLOVES TO REMOVE ASH PAN...

Before removing ash pan, turn switch off or pull power cord plug from 110 volt outlet. Open ash door. Use a good pair of gloves to remove ash pan. Place ash pan on non-combustible surface. Slide an empty ash pan into stove. Close ash door. Turn switch on.

INSTALLATION INSTRUCTIONS FOR A-250, A-350, & A-450

TROUBLE SHOOTING HINTS

PROBLEM	POSSIBLE CAUSE	REMEDY
Stoker runs but doesn't feed coal	Feed nut backed off too far.	Increase feed-see preceding instructions.
	Obstruction in throat of stoker.	Empty hopper and remove obstruction.
	Feed mechanism tight or corroded	Empty hopper –free- use dry coal to prevent reoccurrence.
	Broken or slipping coupling	Replace
	Defective gearbox	Replace
	Feed mechanism out of adjustment	Throat bar height to be 1-3/4" to 2" (Part #11). Pusher bar (Part #12) to be approximately 3/4" behind the face (flat part) of throat bar when in its most forward position with feed nut (Part #19)
Convection blower doesn't run	Lo limit setting in Fan limit switch too high	Set Lo at 110 140
	Furnace not up to temperature.	Set Hi at 110 160
	Fire bed too small	Increase coal feed to get bigger fire.
	Defective thermostat	Replace
	Defective convection blower motor	Replace

INSTALLATION INSTRUCTIONS FOR A-250, A-350, & A-450

TROUBLE SHOOTING HINTS

PROBLEM	POSSIBLE CAUSE	REMEDY
Stoker doesn't run	Main circuit breaker tripped	Reset
	Main fuse blown	Replace
	Fuse on stoker blown	Replace
	Motor out on reset	Press rest button on motor
Stoker motor goes out on reset	Obstruction in throat of stoker	Empty hopper and clear
	Feed mechanism tight or corroded	Empty hopper and free-soaking with penetrating oil-Use dry coal to prevent reoccurrence.
	Motor or gear motor defective	Replace

INSTALLATION INSTRUCTIONS FOR A-250, A-350, & A-450

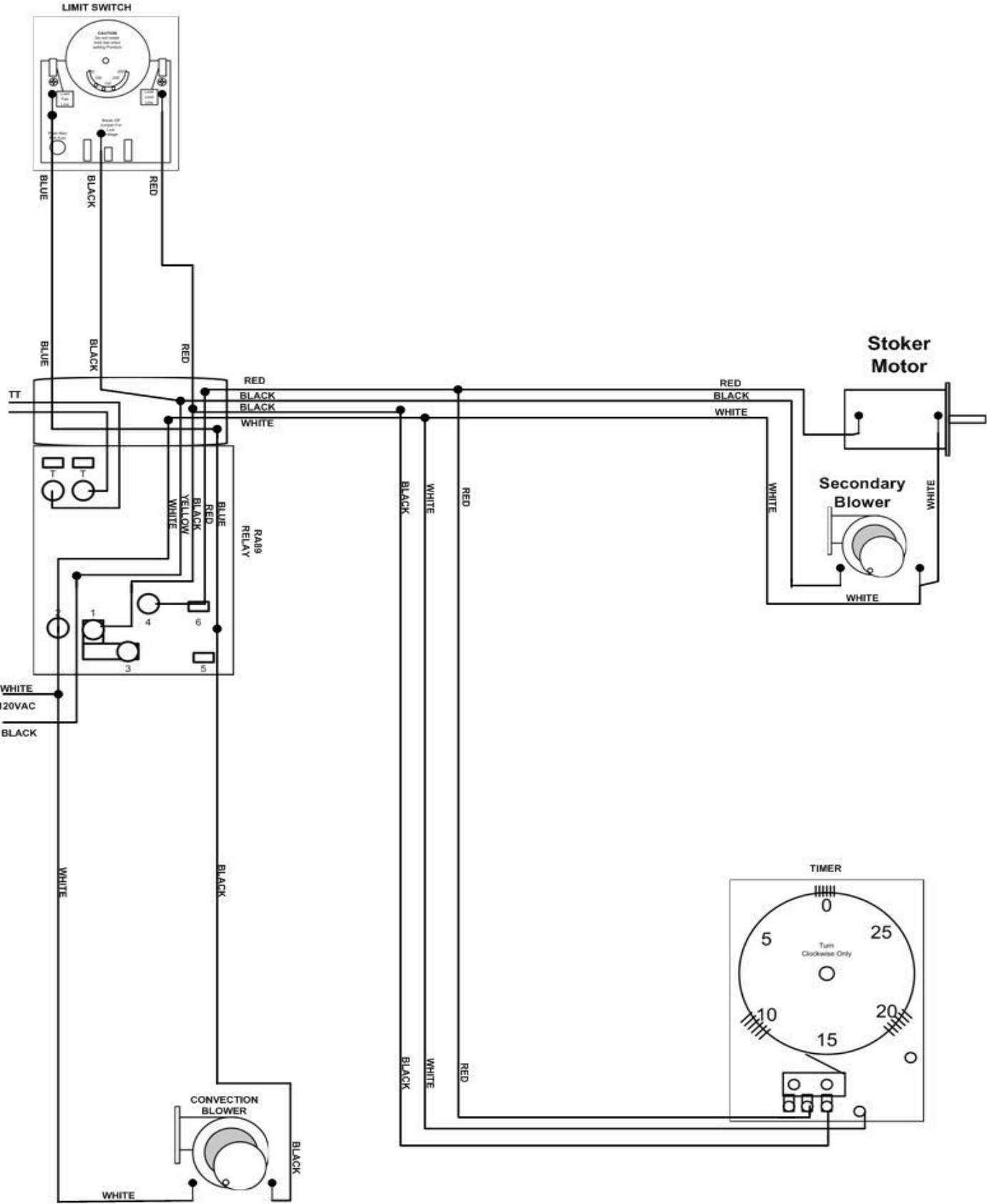

INSTALLATION INSTRUCTIONS FOR A-250, A-350, & A-450

WARM AIR CHECKLIST

- _____ Thermostat
- _____ Blower Motor
- _____ Draft Regulator
- _____ Control-Relay, Timer, and Limit Switch
- _____ Instructions
- _____ Spring Handle
- _____ (2) 3/8 Bolts
- _____ (6) 3/8 Washers
- _____ (4) Hopper Washers
- _____ (2) Drill Screws
- _____ Gaskets
- _____ Receptacle
- _____ Receptacle Cover
- _____ Tag
- _____ (8) Metal Screws
- _____ (2) Clamps

Pulley Sizes

- _____A-80 1/3 Horsepower 7" Blower Pulley 1/2" Motor Pulley 41" Belt
- _____A-150 1/3 Horsepower 7" Blower Pulley 1/2" Motor Pulley 40" Belt
- _____A-250 1/2 Horsepower 8" Blower Pulley 1/2" Motor Pulley 45" Belt
- _____A-350 1 Horsepower 9" Blower Pulley 5/8" Motor Pulley 51" Belt
- _____A-450 1 1/2 Horsepower 10" Blower Pulley 5/8" Motor Pulley 53" Belt

Filter Sizes

- A-80 20" X 20"
- A-150 24" X 24"
- A-250 30" X 24"
- A-350 16" X 25" and 16" X 25"
- A-450 24" X 24" and 16" X 24"